

SR-EOV Series

Vertical Energy Storage System

User Manual

(Gen2)

V1.8



1. Instructions

Thank you very much for choosing the SR-EOV series household energy storage system developed and produced by our company. Please read and understand all contents of the Manual carefully before installing and using the product. If you have any suggestions during the use, please do not hesitate to give us feedback.

1.1 Range of Application

The installation and user manual of SR-EOV series is applicable to the installation and use of the following products:

No	Applicable to the countries with 220V mains voltage	Applicable to the countries with 110V mains voltage
1	SR-EOV05S-220	SR-EOV05S-110
2	SR-EOV10S-220	SR-EOV10S-110
3	SR-EOV15S-220	SR-EOV15S-110
4	SR-EOV20S-220	SR-EOV20S-110

The product should be used in compliance with local standards, laws and regulations, because any non-compliance with the use may lead to personal injuries and property loss.

The drawings provided in this Manual are used to explain the concepts related to the product, including product information, installation guide, electrical connection, system debugging, safety information, common problems and maintenance, etc.

The internal parameters of this product have been adjusted before delivery. No internal parameters can be changed without permission. Any unauthorized changes to the settings will invalidate the warranty, and the Company will not be liable for any loss resulting therefrom.





This Manual and other related documents are an integral part of the product and should be kept properly for onsite installation personnel and related technical personnel to consult.

1.2 Meaning of Abbreviations

AC	Alternating Current
DC	Direct Current
PV	Photovoltaic
BMS	Battery Management System
PCS	Power Conversion System
RJ45	Registered Jack 45
SOC	State Of Charge
C	Charge C-rate
RS485	RS485 Communication Interface
CAN	Controller Area Network

1.3 Symbol Stipulations









There may be following symbols herein, and their meanings are as follows.

Symbols	Description
	Indicate a hazard with a high level of risk which, if not avoided, will result in death or serious injuries.
	Indicate a hazard with a medium level of risk which, if not avoided, could result in death or serious injuries.
	Indicate a hazard with a low level of risk which, if not avoided, could result in minor or moderate injuries.
	Warning information about device or environment safety. If not avoided, equipment damage, data loss, performance degradation or other unanticipated results may be resulted in. The "NOTICE" does not involve any personal injuries.

2 Safety Precautions

2.1 Safety Symbols

This product contains the following symbols, please pay attention to identifying.

Symbols	Description
	Observe enclosed documentation
	Danger. Risk of electric shock!
	Danger of high voltages. Danger to life due to high voltages in the Energy storage system
	Hot surface
	CE certification
	Do not touch the product in 5mins after shutdown
	Comply with RoHS standard
	The Energy storage system should not be disposed together with the household waste.

2.1 General Safety



2.1.1 Important Notice







Before installing, operating and maintaining the device, please read this Manual first and follow the symbols on the device and all the safety precautions in this Manual.

The matters indicated with "DANGER", "CAUTION", "ATTENTION" and "NOTICE" in this Manual do not represent all the safety matters to be observed, but are only the supplements to all the safety precautions. The Company will not be liable for any violation of general safety operating requirements, or any violation of safety standards for the design, production and use of the device. The device must be used in an environment that meets the requirements of the design specifications. Otherwise, the device may fail, and the abnormal device function or component damage, personal safety accident, and property loss arising from this are not covered within the quality assurance scope of the device. When installing, operating, and maintaining the device, the local laws, regulations, and codes shall be followed. The safety precautions in this Manual are only supplements to local laws, regulations, and codes. The Company shall not be liable for any of the following circumstances.

- The device is not run under the conditions of operating described in this Manual.
- The installation and operating environment is beyond the requirements of relevant international or national standards.
- The product is disassembled or changed, or the software code is modified without authorization.
- The operation instructions and safety warnings related with the product and in the documents are not followed.
- Damage of the device is caused by abnormal natural environment (force majeure, such as earthquake, fire, and storm).
- Transportation damage is caused during customer's own transportation.
- The storage condition does not meet the requirements of the product related documents and causes damage.

2.1.2 General Requirements

	<p>Operating when the power is on is strictly prohibited during installation.</p>
	<p>It is strictly prohibited to install, use, and operate any outdoor equipment or cables (including but not limited to transporting equipment, operating equipment and cables, plugging and removing signal ports connected to the outdoor, working at altitude, and outdoor installation) in severe weather, such as thunder, rain, snow, and gale level 6.</p>

	<p>In case of any fire, evacuate the building or equipment area and press the fire alarm bell or dial the fire call. Under any circumstances, re-entry into a burning building is strictly prohibited.</p>
	<p>Under no circumstances should the structure and installation sequence of the device be changed without the manufacturer's permission.</p>
	<p>The battery terminal components shall not be affected during transportation. And, the battery terminal bolts shall not be lifted or transported.</p>
	<p>It is strictly prohibited to alter, damage or block the marks and nameplates on the device.</p>
	<p>The composition and working principle of the entire photovoltaic power generation system, as well as the relevant standards of the country/region where the project is located shall be known fully.</p>
	<p>After the device is installed, the empty packing materials, such as cartons, foam, plastics, and cable ties, shall be removed from the device area.</p>

2.1.3 Personnel Safety

- When operating the device, appropriate personal protective equipment shall be worn. If any fault that may lead to personal injury or damage of the device is found, immediately terminate the operation, report to the responsible person, and take effective protective measures.
- Before using any tools, learn the correct method of using the tool to avoid injuries and damage of the device.
- When the device is running, the temperature of the case is high, which may cause burns. Therefore, do not touch the case.
- In order to ensure personal safety and normal use, reliable grounding should be carried out before use.
- Do not open or damage the battery. The electrolyte released is harmful to skin and eyes, so avoid touch it.
- Do not place irrelevant items on the top of the device or insert them into any part of the device.
- Do not place flammable items around the device.
- Never place the battery in the fire to avoid explosion and prevent the personal safety from being endangered.
- Do not place the battery module in water or other liquids.

- Do not short-circuit the battery terminals, because short-circuiting of the battery may cause combustion.
- The battery may pose a risk of causing electric shocks and large short-circuit currents. When using the battery, the following precautions should be paid attention to:
 - a) The metal objects, such as watch and rings, shall be removed.
 - b) Tools with insulated handles should be used.
 - c) Rubber gloves and shoes should be worn.
 - d) The charging power supply shall be disconnected before connecting or disconnecting terminals of the battery.
 - e) Check whether the battery is accidentally grounded. If the battery is accidentally grounded, remove the power supply from the ground.
- Do not clean the internal and external electrical components of the cabinet with water or detergent.
- Do not stand, lean or sit on the device.
- Do not damage any modules of the device.

2.2 Personnel Requirements

- The personnel in charge of installation and maintenance must be strictly trained to understand all safety precautions and master proper operation methods.
- Only qualified professionals or trained personnel are allowed to install, operate and maintain the device.
- The personnel who operate the device, including the operators, trained personnel and professionals, must have special operation qualifications required by the local country, such as high voltage operation, working high above the ground, and special equipment operation qualification.
- The replacement of device or components (including software) must be carried out by professionals or authorized personnel.

2.3 Electrical Safety

2.3.1 General Requirements



Before carrying out electrical connections, ensure that the device is not damaged, or an electric shock or fire may occur.



Never install or remove any power cables when the power is on. The electric arcs or sparks may be generated at the moment when the power cable contacts with the conductor, which may cause fire or personal injuries.

- All the electrical connections must meet the electrical standards of the country/region where the project is located.
- The cables prepared by users themselves shall comply with local laws and regulations.
- Special insulating tools should be used in high-voltage operations.
- Before connecting the power cord, ensure that the label identification on the power cord is correct.
- Operations on the device are allowed only five minutes after the device is completely powered off.
- The insulation layer of the cable may be aged or damaged when the cable is used in a high temperature environment. Therefore, the distance between the cable and the heat source must be at least 30mm.
- Cables of the same type should be bundled together. Whereas, the cables of different types should be routed at least 30mm apart, and shall not be wrapped together or crossed.

2.3.2 Grounding Requirements

- When installing the device to be grounded, the protective grounding wire must be installed first; when removing the device, the protective grounding wire must be removed at last.
- It is forbidden to destroy the grounding conductor.
- It is forbidden to operate the device without a grounding conductor installed.
- The device shall be permanently connected to the protective grounding wire. Before operating the device, electrical connection of the device shall be checked to ensure that the device is reliably grounded.

2.4 Installation Environment Requirements

- This product is for indoor use only, and is strictly prohibited to be used in outdoor environment.
- Do not install or use this product in an environment where the temperature is lower than -10 °C or higher than 50 °C.
- It should be installed in a dry and well-ventilated environment to ensure good heat dissipation performance.
- The product can be installed at a maximum altitude of 2,000m.
- The installation position should be away from the fire source.
- The product should be installed and used away from children and animals.
- The installation position should be far away from water sources, such as faucets, sewer pipes, and sprinklers, to avoid entering of water.
- The device should be placed on a firm and flat supporting surface.
- Do not place any inflammable or explosive items around the device.
- When the device is running, do not block the ventilation vent or heat dissipation system to prevent fire caused by high temperature.

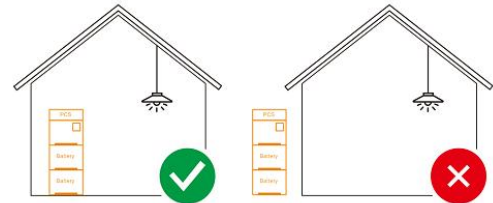

The operation and service life of the energy storage is related to the operating temperature. The energy storage should be installed at a temperature equal to or better than the ambient temperature.

**Max+50°C****Min-10°C****RH.+5%~+95%**

3 Product Introduction

3.1 Brief Introduction to Product

SR-EOV is a new generation of household energy storage system with two output specifications of 220V and 110V, which can meet the diversified needs of global users. The SR-EOV energy storage system adopts a modular design, including power modules and battery expansion modules, so it can be easily combined into a system of any capacity required by the user.

The lithium iron phosphate batteries with high performance and long service life are used in the energy storage module. Meanwhile, the modular structure design is adopted. Each energy storage module is internally integrated with the intelligent BMS system, which can be easily expanded and can be combined into 20Kwh battery pack at most.

The brand new topological circuit design is adopted in the power module, which can realize the energy exchange between photovoltaic, mains, battery and loads, and has the function of photovoltaic and mains charging. The photovoltaic charging module adopts the latest optimized MPPT tracking technology, which can quickly track the maximum power point of the photovoltaic array in any environment, and obtain the maximum energy of the solar panel in real time. In addition, MPPT has a wide voltage range. The advanced control algorithm is adopted in the mains charging module to realize the fully-digital double closed-loop control of voltage and current, so the control precision is high and the volume is small. The AC voltage input range is wide, and the input/output protection functions are complete, which can realize the stable and reliable charging and protection of batteries. The inverter module is based on the full-digital intelligent design, adopts the advanced SPWM technology, outputs pure sine wave, converts direct current into alternating current, and is applicable for household appliances, power tools and other AC loads.

The typical topological diagram for application of the system is as follows:

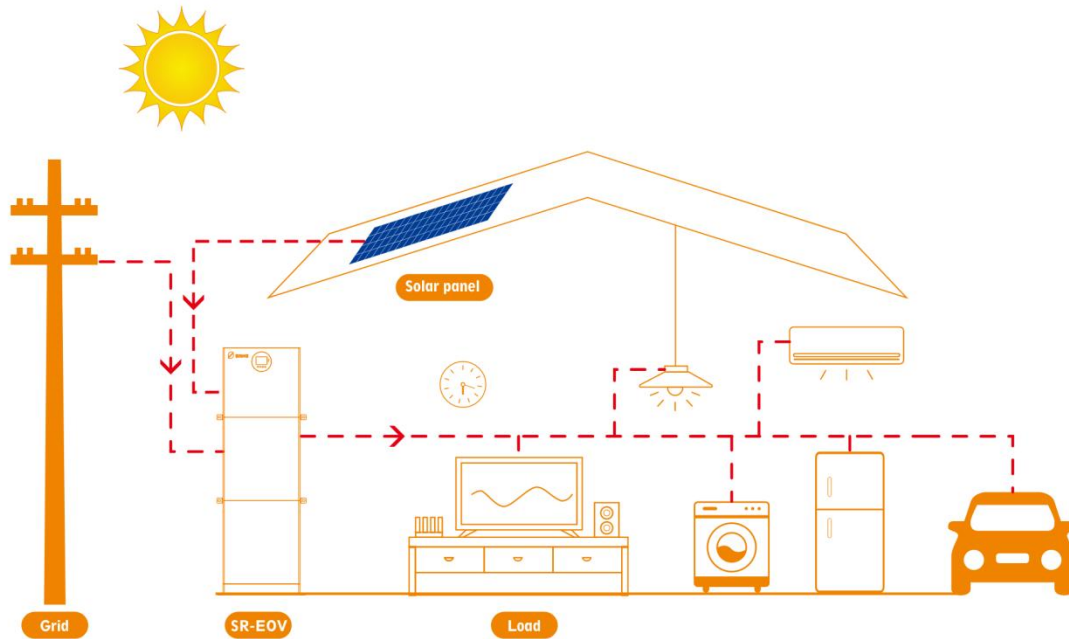

3.2 System Specifications

Product model	Battery Energy	Rated Output Power	Rated Output Voltage (Vac)	Frequency	Charge Current	Max. PV Power
SR-EOV05S-220	5.12kWh	5000W	230Vac	50Hz	0 ~ 100A	5500W
SR-EOV05S-110	5.12kWh	5000W	120Vac	60Hz	0 ~ 100A	5500W
SR-EOV10S-220	10.24kWh	5000W	230Vac	50Hz	0 ~ 100A	5500W
SR-EOV10S-110	10.24kWh	5000W	120Vac	60Hz	0 ~ 100A	5500W
SR-EOV15S-220	15.36kWh	5000W	230Vac	50Hz	0 ~ 100A	5500W
SR-EOV15S-110	15.36kWh	5000W	120Vac	60Hz	0 ~ 100A	5500W
SR-EOV20S-220	20.48kWh	5000W	230Vac	50Hz	0 ~ 100A	5500W
SR-EOV20S-110	20.48kWh	5000W	120Vac	60Hz	0 ~ 100A	5500W

3.3 Model Coding

The model coding of the energy storage battery is as follows:

SR-EOV05S-110

① ② ③ ④

Identifier	Meaning	Value
①	Product type	EOH: horizontally-mounted EOV: vertically-mounted EOS: wall-mounted
②	Energy storage capacity level	05: The battery capacity is 5kWh 10: The battery capacity is 10kWh
③	Product category	B: Energy storage battery C: Power conversion module S: Energy storage system
④	Output voltage	110: American standard 220: National standard

3.4 Description of Energy Storage Capacity

SR-EOV series energy storage system supports the capacity expansion with up to four energy storage modules.

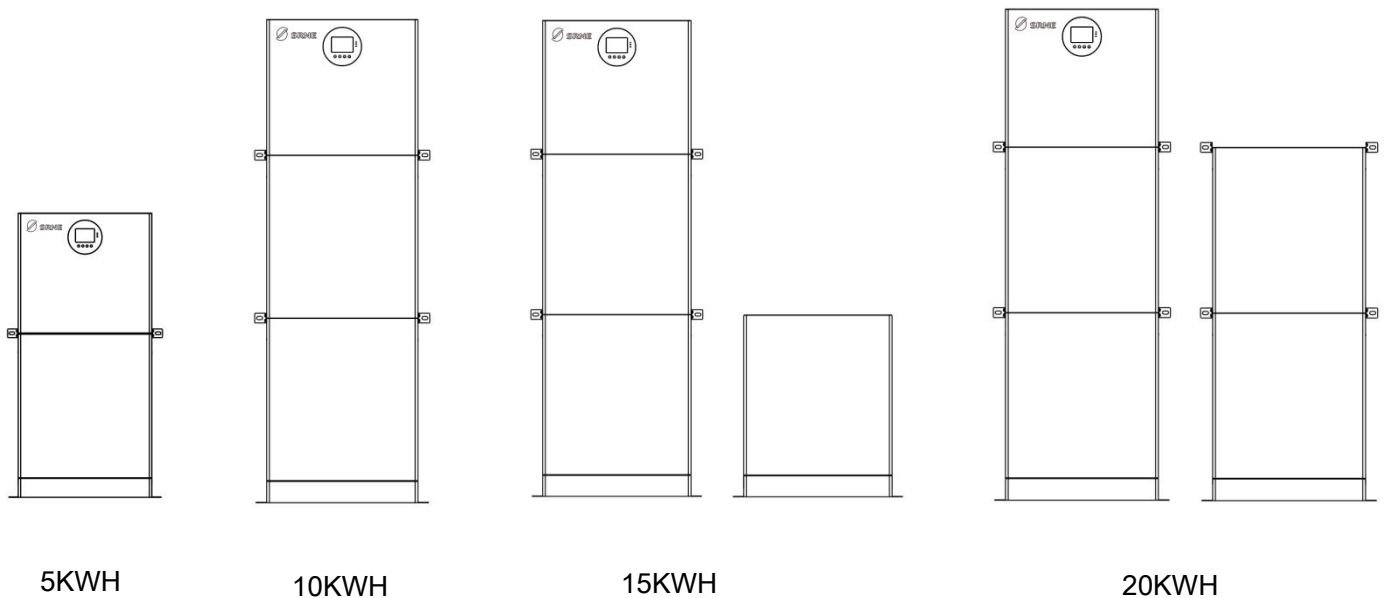

3.5 Appearance Description

3.5.1 Dimensions

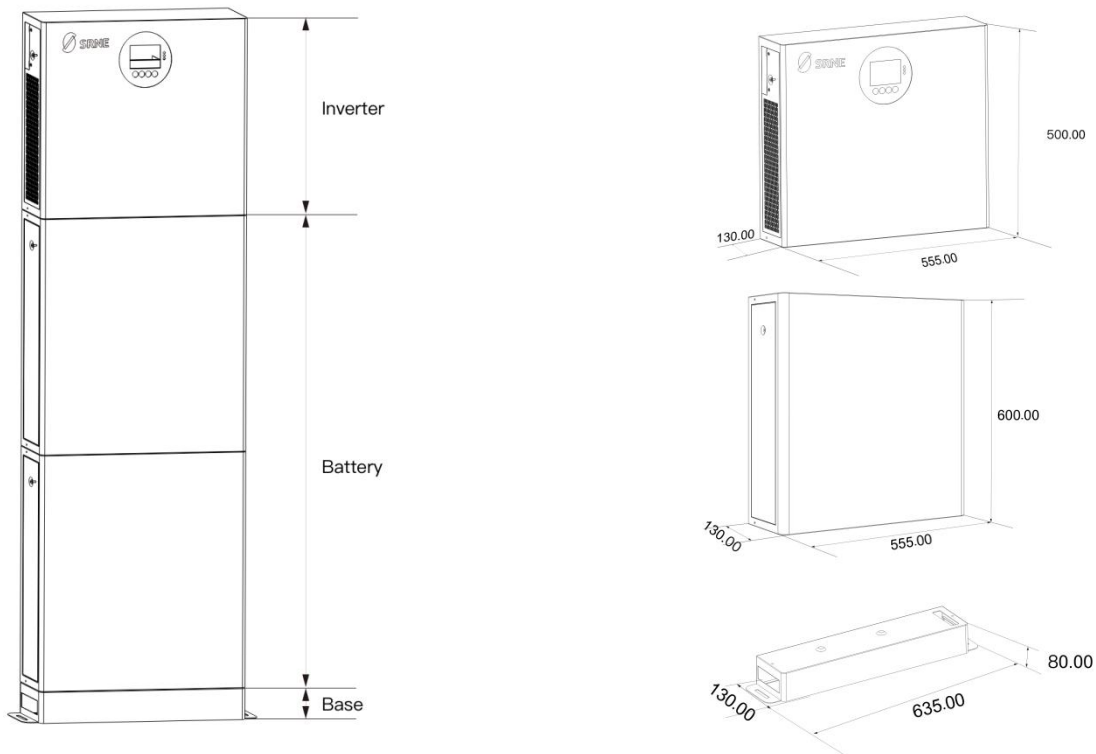

Inverter dimensions (L*W*H) :555*130*500mm

Battery dimensions (L*W*H) :555*130*600mm

Base dimensions (L*W*H) :635*130*80mm

3.5.2 Power Conversion System Module

The power of power conversion system is 5.0KW.

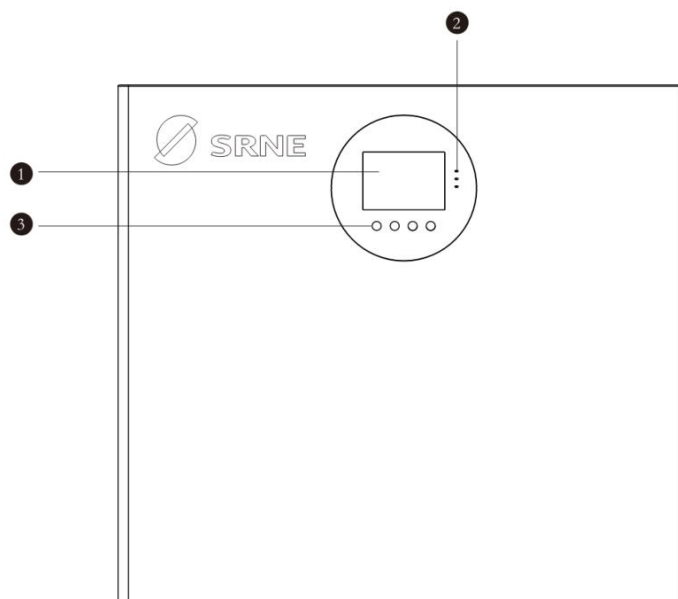

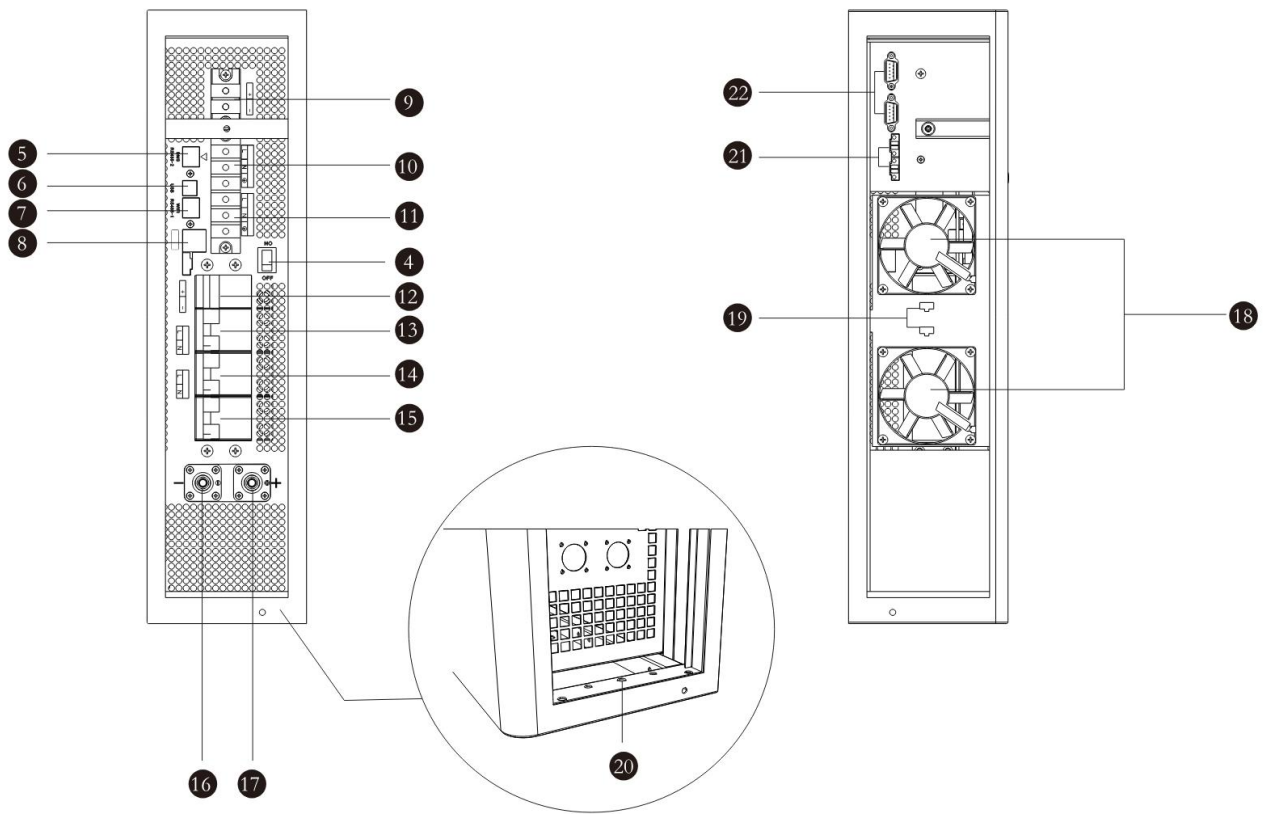

① LCD screen	② LED indicator	③ Touch keys	④ Inverter ON/OFF
⑤ RS485-2 (Connect battery)	⑥ USB (Connect PC)	⑦ RS485-1 (Connect WiFi)	⑧ Dry contact (Start generator)
⑨ PV input port	⑩ AC output port	⑪ AC input port	⑫ PV input switch
⑬ AC output switch	⑭ AC input switch	⑮ Battery switch	⑯ Battery Negative
⑰ Battery Positive	⑱ Cooling fan	⑲ Fan connector	⑳ Grounding screw
㉑ Current sharing detection	㉒ Parallel communication		

Communication interface definition

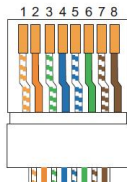
Number	Communication	Function	Interface Type	Picture	instruction
⑤	RS485-2	Connect battery	RJ45		7-RS485-A 8-RS485-B

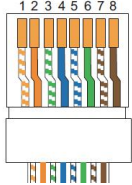
⑦	RS485-1	Connect WiFi	RJ45		1-5V 2-GND 7-RS485-A 8-RS485-B
---	---------	--------------	------	---	---

3.5.3 Energy Storage Battery Module

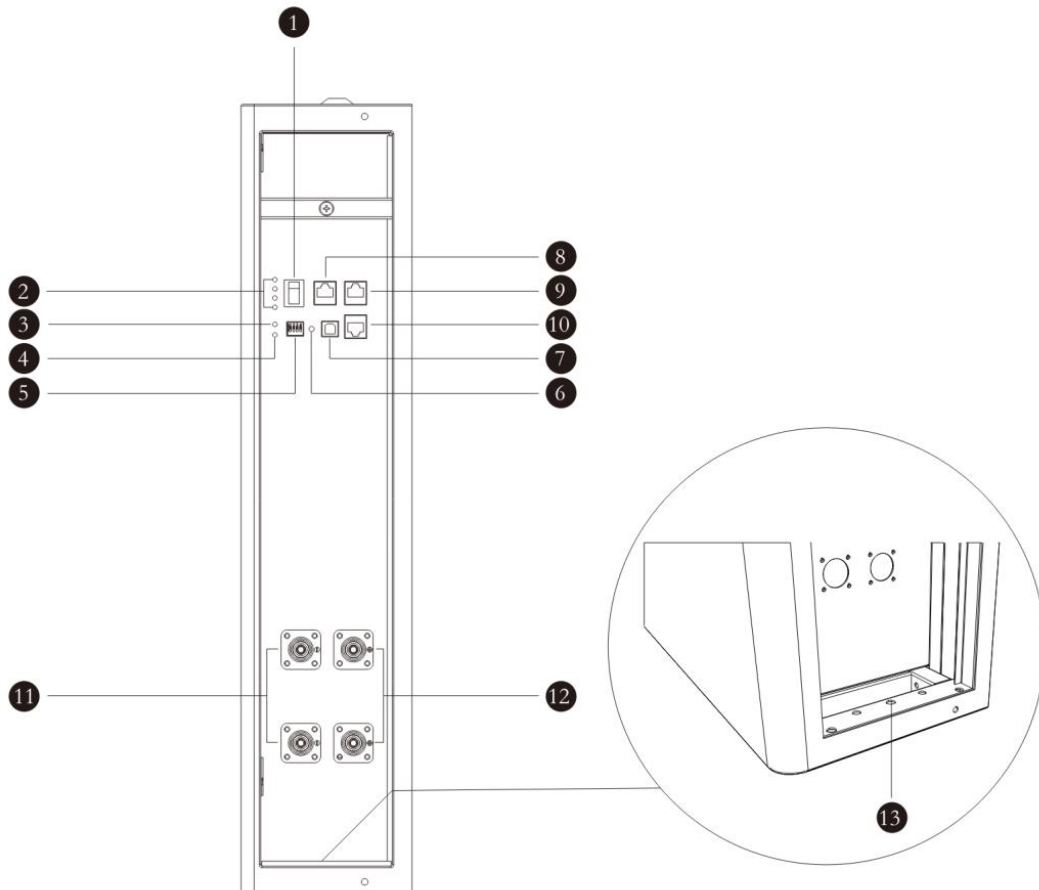

① Battery turn On/Off	② LED (SOC)	③ LED (RUN)	④ LED (ALM)
⑤ Address	⑥ Reset	⑦ USB (Connect PC)	⑧ RS485/CAN (Connect inverter)
⑨ RS485 (Connect other battery)	⑩ RS485 (Connect other battery)	⑪ Battery Negative	⑫ Battery Positive
⑬ Grounding screw			

Communication interface definition

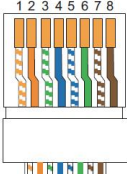
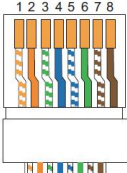
Number	Communication	Function	Interface Type	Picture	instruction
⑧	RS485/CAN	Connect inverter	RJ45		1-RS485-B 2-RS485-A 4-CAN-H 5-CAN-L
⑨ ⑩	RS485-2	Connect other battery	RJ45		1-RS485-B 2-RS485-A 7-RS485-A 8-RS485-B

4 Application Scenarios

The lithium iron phosphate batteries with high performance and long service life are used in the energy storage module. Meanwhile, the modular structure design is adopted. Each energy storage module is internally integrated with the intelligent BMS system, which can be easily expanded and can be combined into 20Kwh battery pack at most.

The battery storage can be combined with SRNE brand inverter to form an off-grid photovoltaic system, which can solve the problem of electricity consumption in areas without electricity.

4.1 Application Scenarios

4.1.1 Application Scenarios with Only Mains Power but No Photovoltaic

When the mains is normal, it charges the battery and supplies power to the loads.

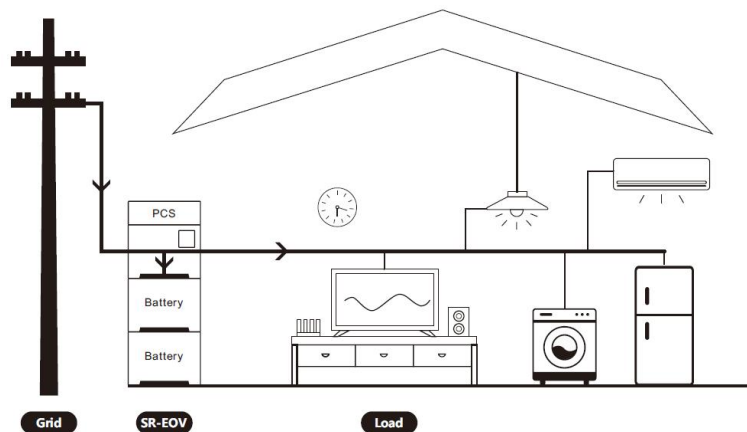

When the mains is disconnected or stops working, the battery supplies power to the load through the power module.

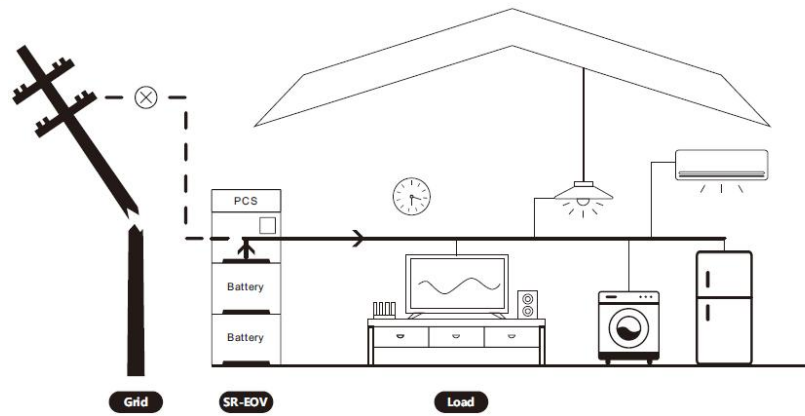

4.1.2 Application Scenarios with Only Photovoltaic but No Mains Power

During the day, the photovoltaic directly supplies power to the loads while charging the battery.

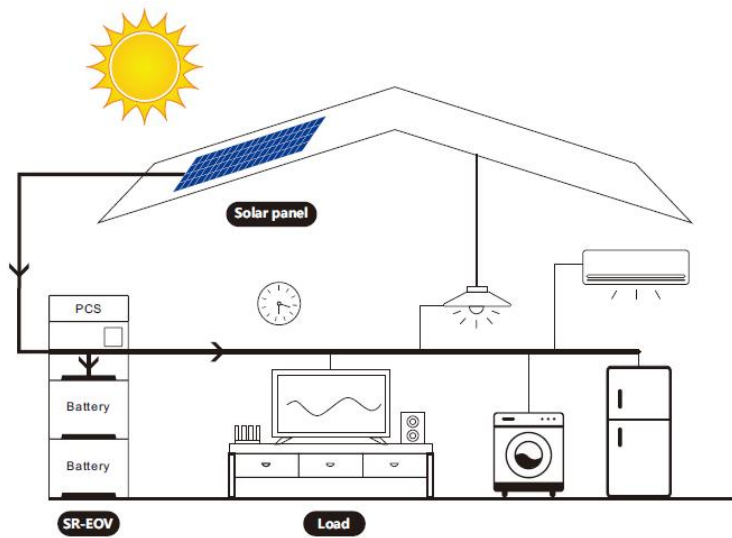

At night, the battery supplies power to the loads through the power module.

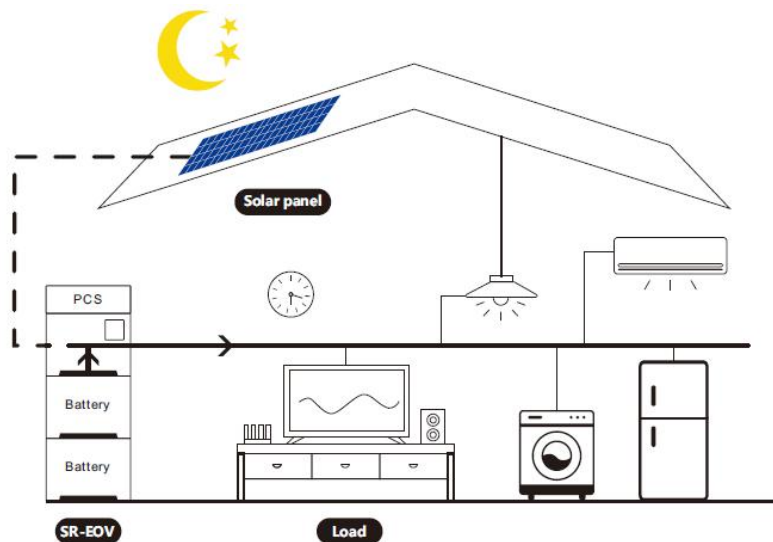

4.1.3 Complete Application Scenarios

During the day, the mains and photovoltaic simultaneously charge the battery and supply power to the loads.

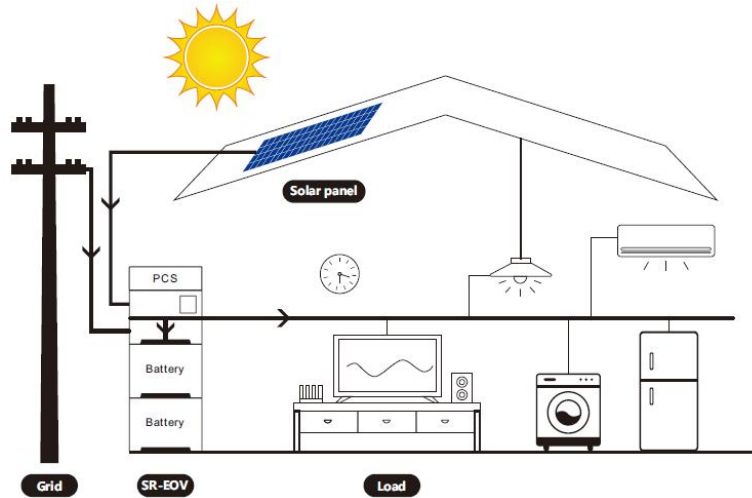

At night, the mains supplies power to the loads, and continues to charge the battery, if the battery is not fully charged.

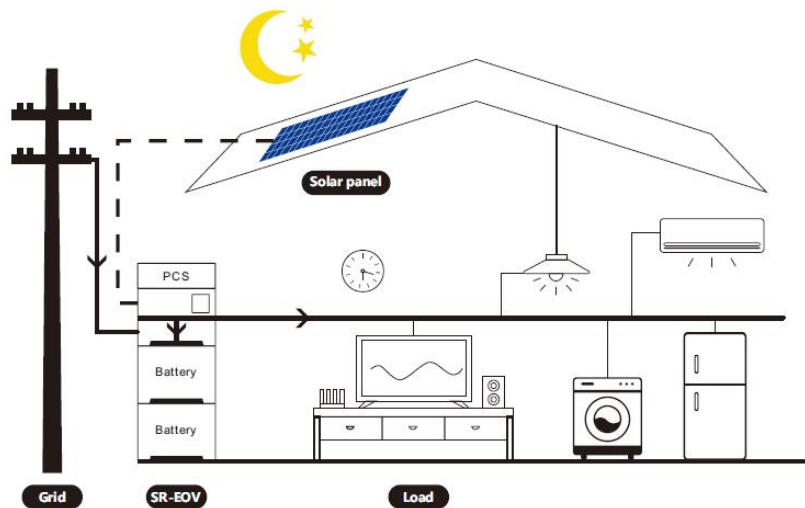

If the mains is disconnected, the battery supplies power to the loads.

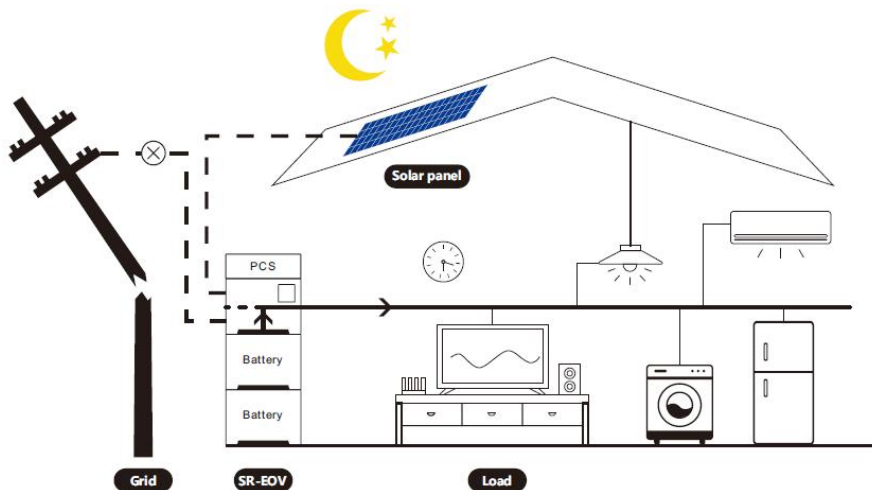

4.2 Load Working Mode

Load working mode	Inverter setting	Description
PV priority mode	PV 1ST	switching to the Mains when the PV fails or the battery is lower than the set value of parameter
Mains priority mode (Default)	AC 1ST	Mains priority mode, switching to inverter only when the mains fails. When the battery is full, the load power is supplied by the hybrid of PV and the utility.
Battery priority mode	BT 1ST	switching to the mains only when the battery is under voltage or lower than the set value of parameter

5 System Installation



5.1 Inspections before Installation



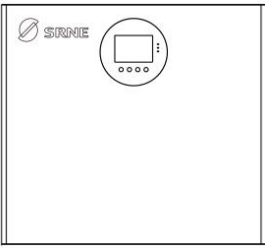

Inspection of outer package

Before opening outer package of the energy storage, check if there is any visible damage on the outer package, such as holes, cracks or other signs of possible internal damage, and check the type of energy storage. If there is any abnormality on the package or model of the energy storage is inconsistent, do not open it and contact us as soon as possible.



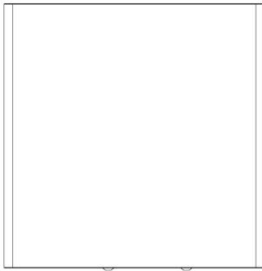
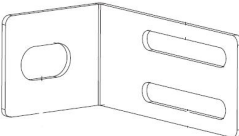
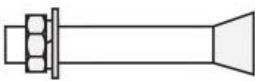

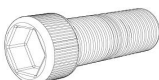



Inspection of deliverables

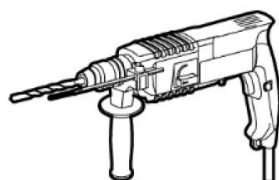

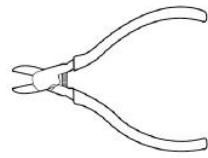
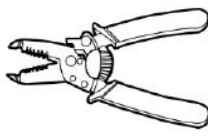

After opening outer package of the energy storage, check if the deliverable is complete and whether there is any visible external damage. If any items are missing or damaged, please contact us.

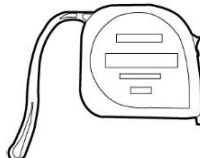
NO.	Picture	Item	Quantity	Specification	Source
1		Inverter	1	5.0kW/48V,110V/220V	Inverter Package
2		Base	1	635*130*80mm	Inverter Package

3		Battery	N	5.12kWh/51.2V	Battery Package
4		Mounting Frame	2*N	80*44mm	Battery Package
5		Mounting Frame Screw	2*(N+1)	M8*60 expansion bolt	Battery Package
6		Screw	8*N	M5*10	Battery Package
7		Fixing screw	2*N	M6*35	Battery Package
8		Hexagon wrench	N	120*30mm	Battery Package
N: Number of batteries					

5.2 Preparation of Tools and Meters

Types	Tools and meters		
Installation tool			
			  
			

Personal protective equipment			
			

5.3 Selection of Installation Location

5.3.1 Basic Requirements

- When the energy storage is running, the temperature of the case and the radiator will be high. Therefore, do not install them in a place that is easy to touch.
- Do not install in areas where flammable and explosive materials are stored.
- If the energy storage is installed in areas with salt damage, it will be corroded and may cause fire. Therefore, do not install it outdoors in areas with salt damage. The areas with salt damage are defined as the areas which are not 500m away from shore or will be affected by sea breezes. The areas affected by the sea breezes vary depending on meteorological conditions (e.g. typhoons, monsoons) or topographical conditions (dams, hills).
- Do not install in the place where children can touch.
- The energy storage cannot be installed forwardly, horizontally, inversely, backwardly or sideways.
- When drilling holes on walls or ground, the goggles and protective gloves shall be worn.
- During drilling, the device should be shielded to prevent debris from falling into the device. After drilling, the debris shall be cleaned up in time.
- When handling any heavy objects, you should be prepared to bear loads to avoid being crushed or sprained.
- When handling the device by hand, wear protective gloves to avoid injury.

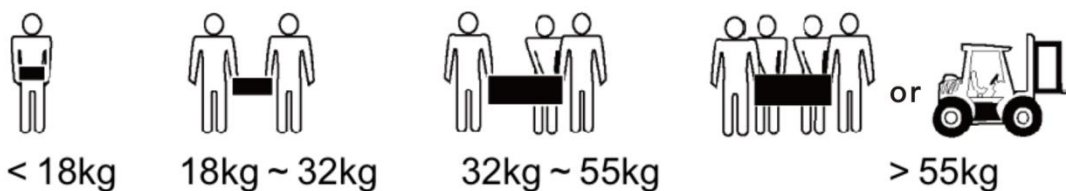

5.3.2 Installation Space Requirements

When installing the energy storage, certain space shall be left around it to ensure sufficient space for installation and heat dissipation.

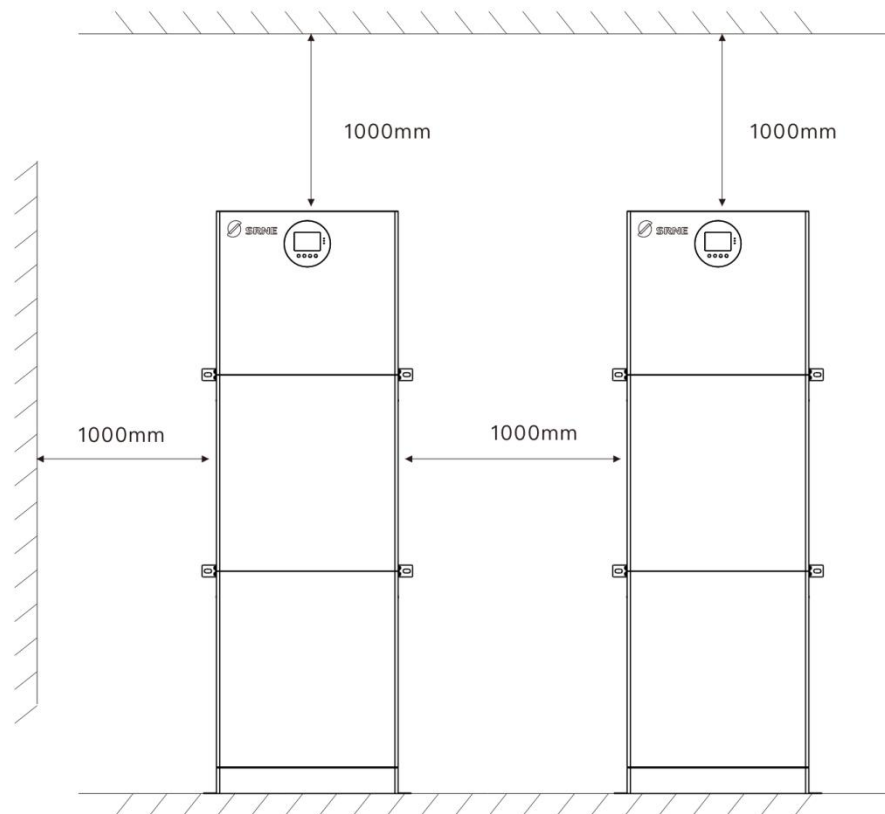

5.4 Device Installation

5.4.1 Installation Location Selection

Determine the installation location, please choose a flat ground and a solid wall as the installation location.

First, determine the installation position of the base, the fixed size is 635mm.

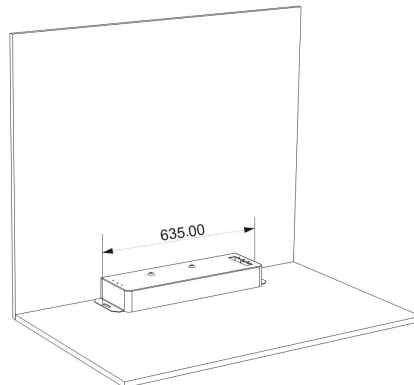

Second, determine the installation position of the battery and inverter.

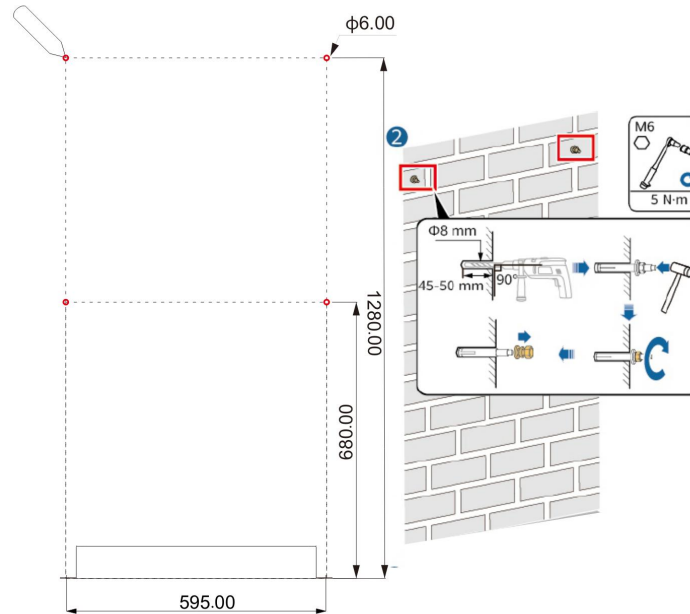

5.4.2 Install Expansion Bolts



In order to avoid electrical shock or other injury, inspect existing electronic or plumbing installations before drilling holes.



Choose suitable firm wall with thickness greater than 80mm.

According to the hole position, drill 2 holes on the ground and 4 holes on the wall, $\phi 6$, depth 45~50mm. Tap the M8 screw into the above hole and screw on the nut.

5.4.3 Mounting the base

Fasten the base to the expansion screw.

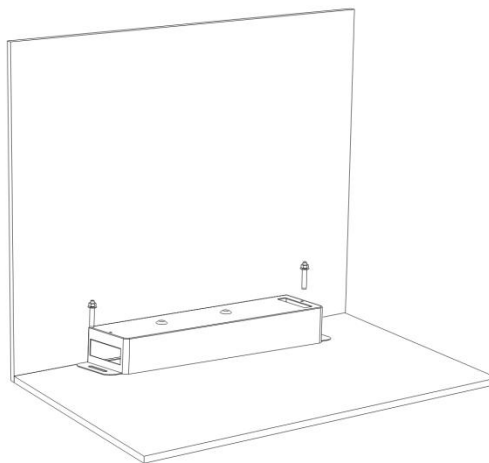

5.4.4 Install Battery Pack



The battery pack is very heavy, which requires multiple people to install.

Place the battery on the base, and then tighten the fixing screws on both sides.

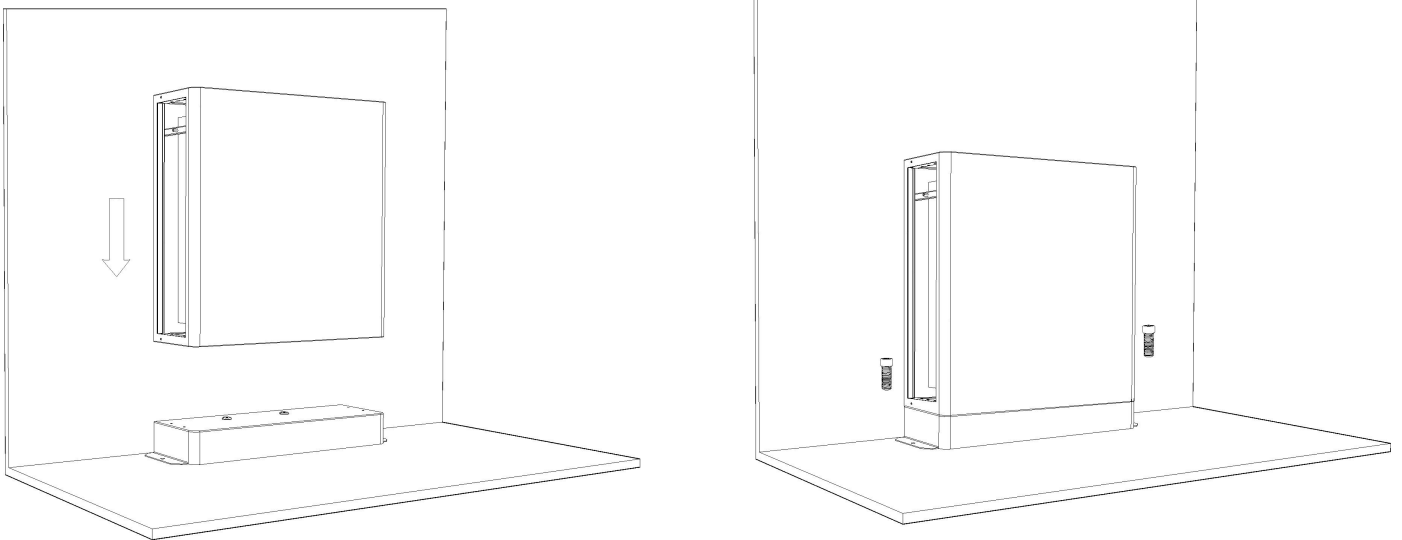

Install the second battery in the same way. After the installation is complete, install the wall fixing bracket.

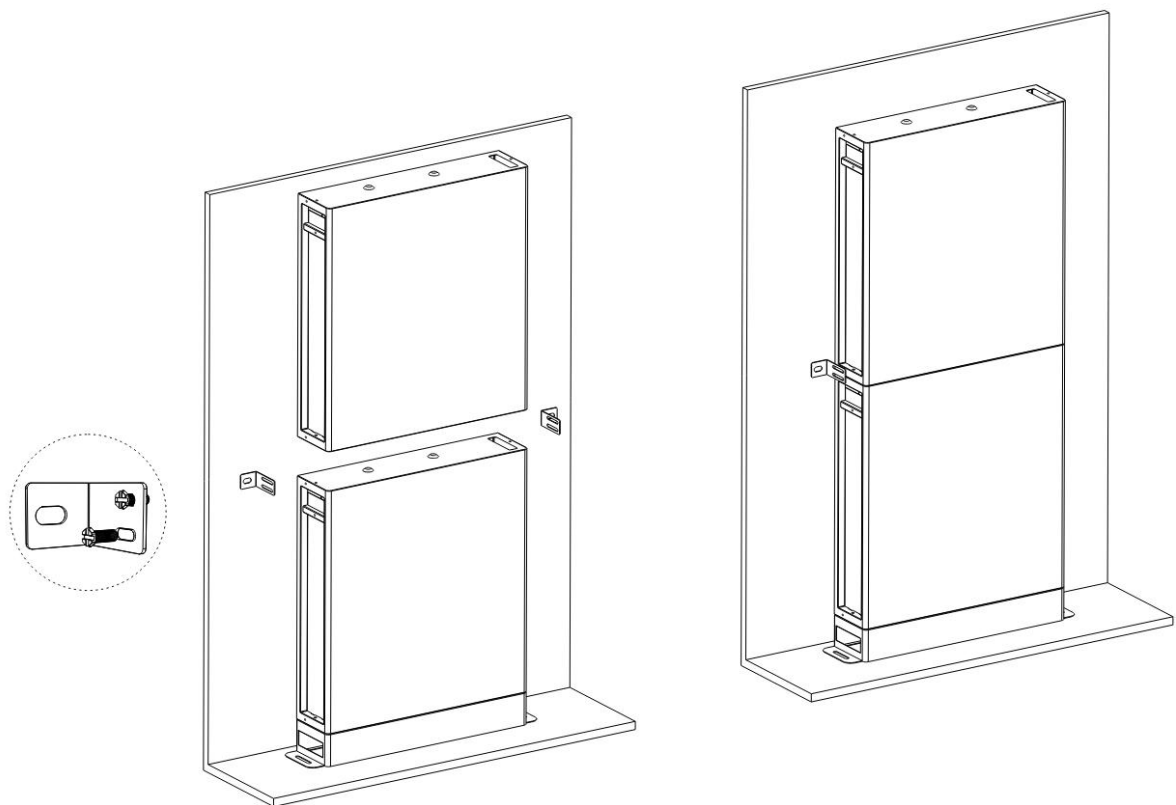

5.4.5 Install Inverter

The installation method of the inverter is the same as that of the battery.

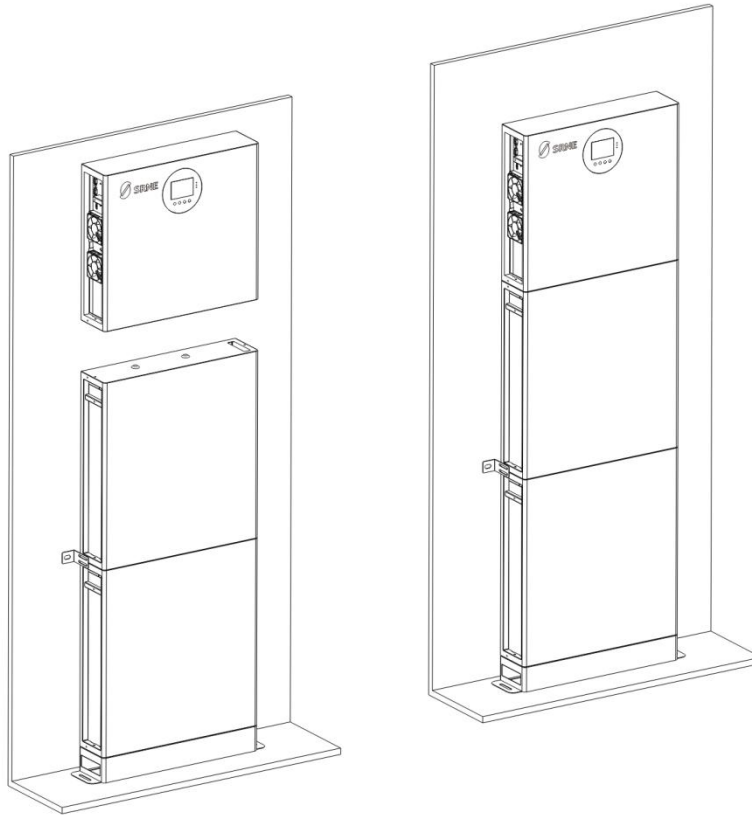

6 Electrical Connection









Before electrical connection, please ensure that the switches of the energy storage are in the "OFF" state. Otherwise, the high voltage of the device may cause electric shock.



The operations related to electrical connections must be carried out by professional electrical technicians. When carrying out electrical connections, the operator must wear personal protective articles.

6.1 Preparation of Cables

No.	Cables	Description	Recommended specifications	Source
1	Power Cable	Power cable between the storage battery and inverter		Battery Package
2	Signal line	Signal cable between battery modules or between battery and inverter		Battery Package

3	Wiring ring	Connect wires and terminals		Inverter Package
4	Parallel communication line	Communication cable when multiple inverters are connected in parallel		Inverter Package (Optional)
5	Current sharing detection line	Current sharing line when multiple inverters are connected in parallel		Inverter Package (Optional)
6	Expand Capacity Power Cable	Power cable between the storage battery, 15kw and 20kw capacity battery use, 1.5m		(Optional)
7	Expand Capacity Signal line	Power cable between the storage battery, 15kw and 20kw capacity battery use, 2.0m		(Optional)
8	Photovoltaic input line	Cable between the photovoltaic panel and power module	Cable diameter 6mm ² /10AWG	Prepare by the user itself
9	AC input line	Cable between AC input and power module	Cable diameter 10mm ² /7AWG	Prepare by the user itself
10	AC output line	Cable between AC output and power module	Cable diameter 10mm ² /7AWG	Prepare by the user itself

6.2 Internal Electrical Connection of Energy Storage

6.2.1 Connecting Power Cord

Before connecting the energy storage battery module, ensure that the energy storage battery is not working and the indicator lights on the battery are OFF. The power cord delivered with the product together should be used to connect the positive and negative terminals of other batteries or power modules. It shall be noticed that the red cable should be connected to the red terminal (positive battery terminal) and the black cable to the black terminal (negative battery terminal).



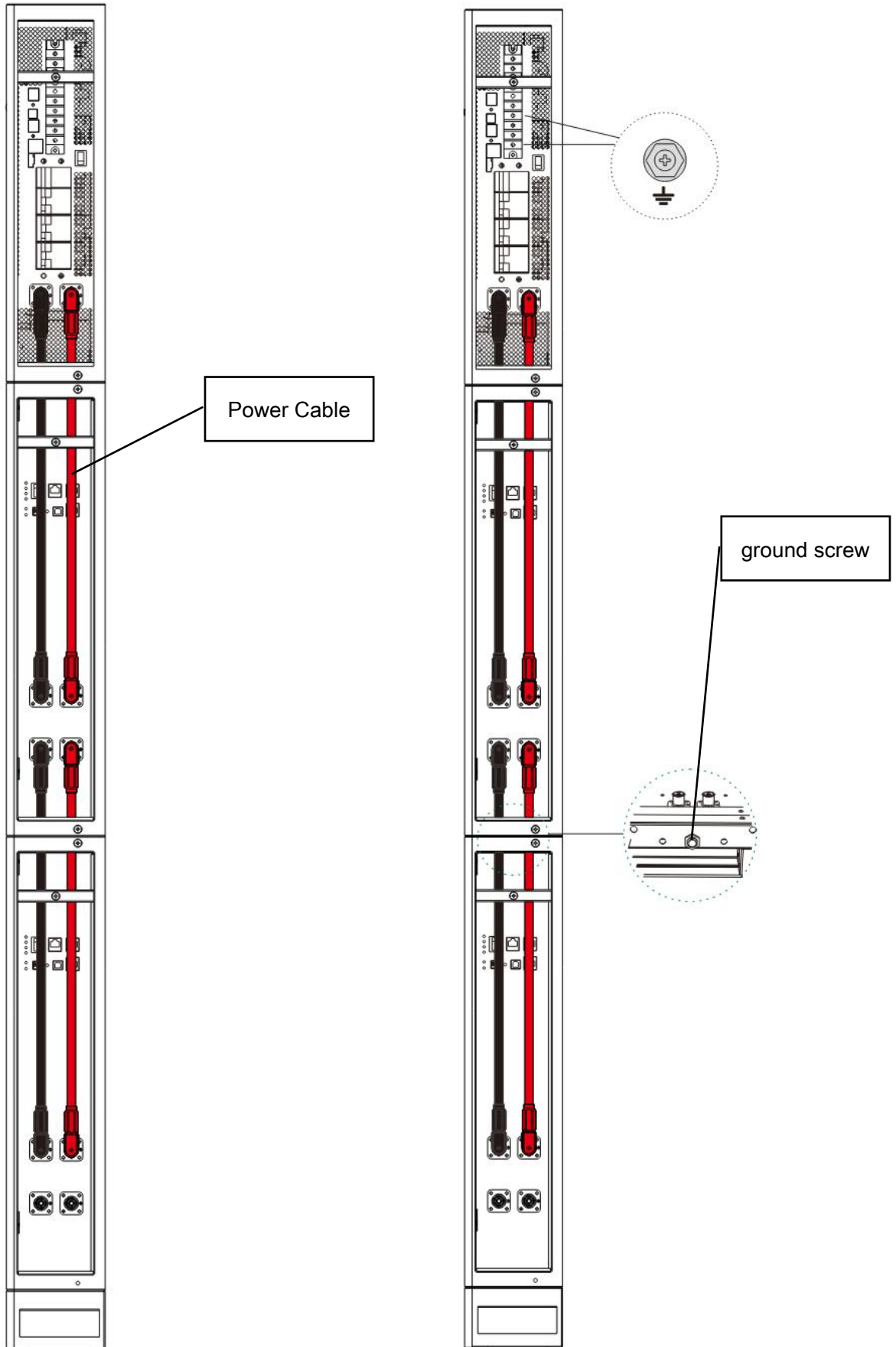

6.2.3 Connecting Signal Line

The signal line delivered with the product together shall be used to connect RS485-Battery interface for each battery module.

The inverter communication interface connects the 485-BMS and the 485-INV interface of the battery.

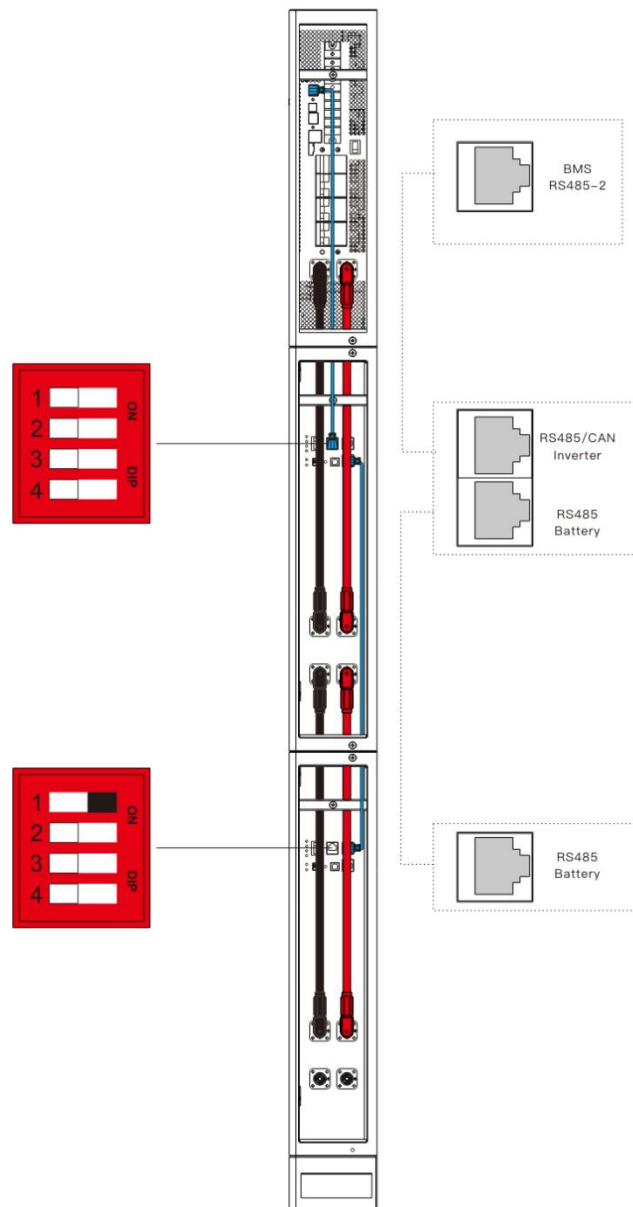
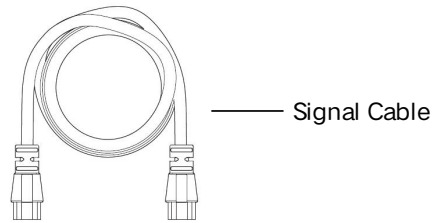

6.2.4 Energy Storage Battery Module Address Setting

If multiple energy storage battery modules are used in parallel, the address of the energy storage battery module needs to be set. The address is set to 0~3, and the address of each module cannot be repeated.

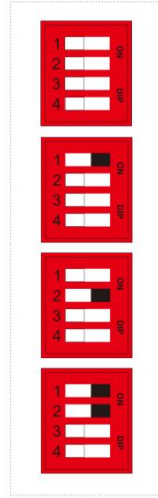

The address of the battery connected to the inverter must be set as 0.

6.3 External Electrical Connection of Energy Storage

6.3.1 Connecting AC Input

According to the cable sequence and terminal position shown in the figure below, correctly connect the AC input line. Please pay attention to L and N and avoid short-circuit when wiring.

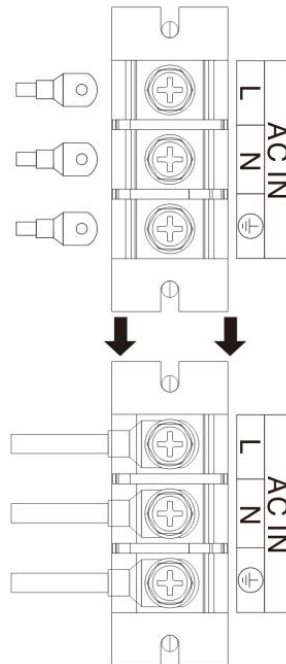

6.3.2 Connecting AC Output

According to the cable sequence and terminal position shown in the figure below, correctly connect the AC output cable. When wiring, please pay attention to L and N and avoid short-circuit.

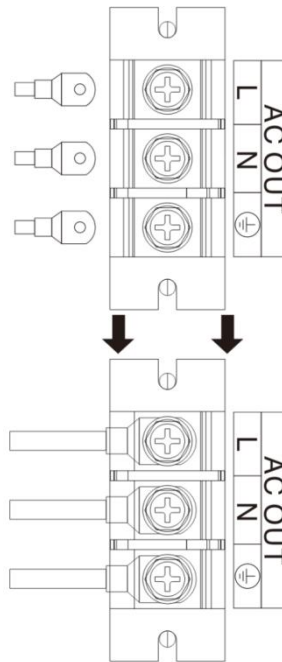

6.3.3 Connecting Photovoltaic Input

According to the cable sequence and terminal position shown in the figure below, correctly connect the PV input cable. When wiring, please pay attention to the positive and negative poles and avoid short-circuit.

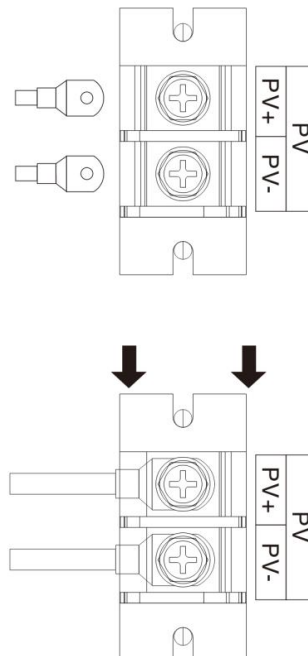

6.3.4 Wiring specifications

Models	Recommended PV wiring diameter	Recommended AC input wiring diameter	Recommended AC output wiring diameter
SR-EOV05S-110V	6mm ² /10AWG	10mm ² /7AWG	10mm ² /7AWG
SR-EOV05S-220V	6mm ² /10AWG	10mm ² /7AWG	10mm ² /7AWG

6.4 Electrical Connection of Multiple Battery Modules

6.4.1 Connecting Power Cord And Signal Line

If you need 15kwh or 20kwh batteries, you can choose to connect multiple batteries through parallel power cable and Signal Line, At the same time, it is necessary to set the correct battery address.

Expand capacity power cable of battery modules are optional products. If necessary, please contact your local dealer.

15kwh Wiring diagram:

Battery wire connection

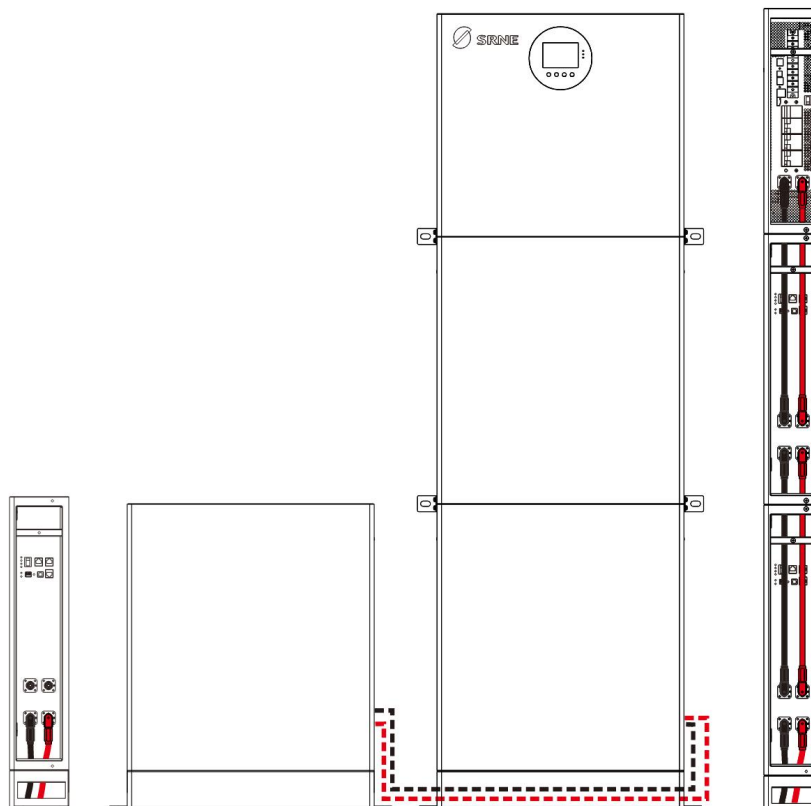

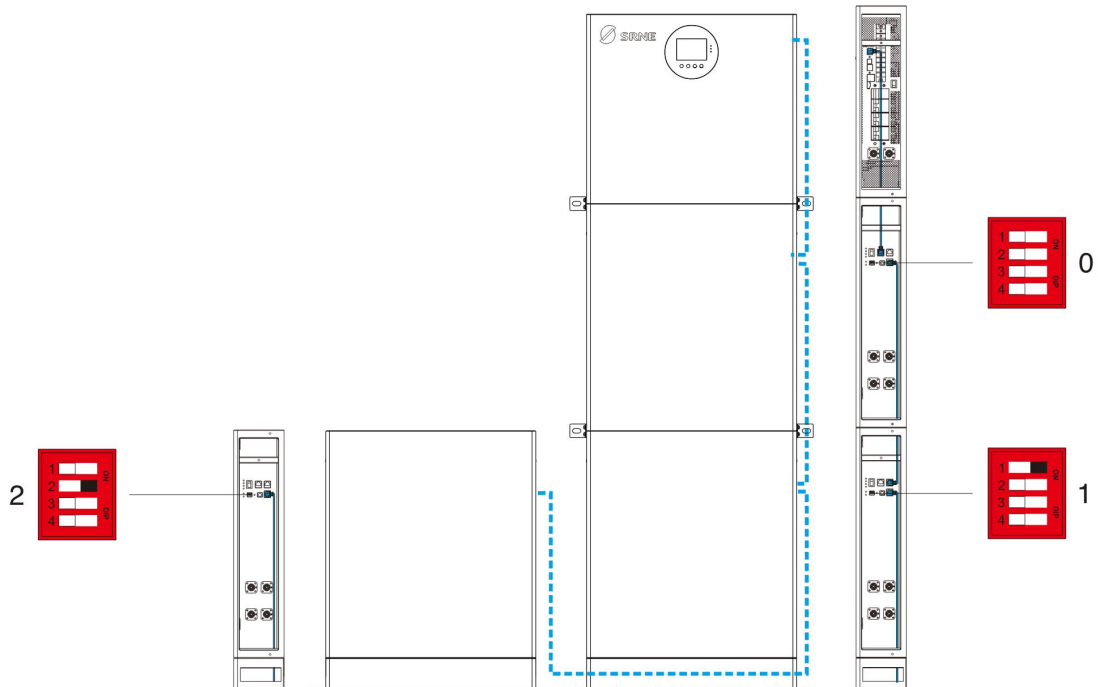
Signal line connection and address setting

20kwh Wiring diagram:

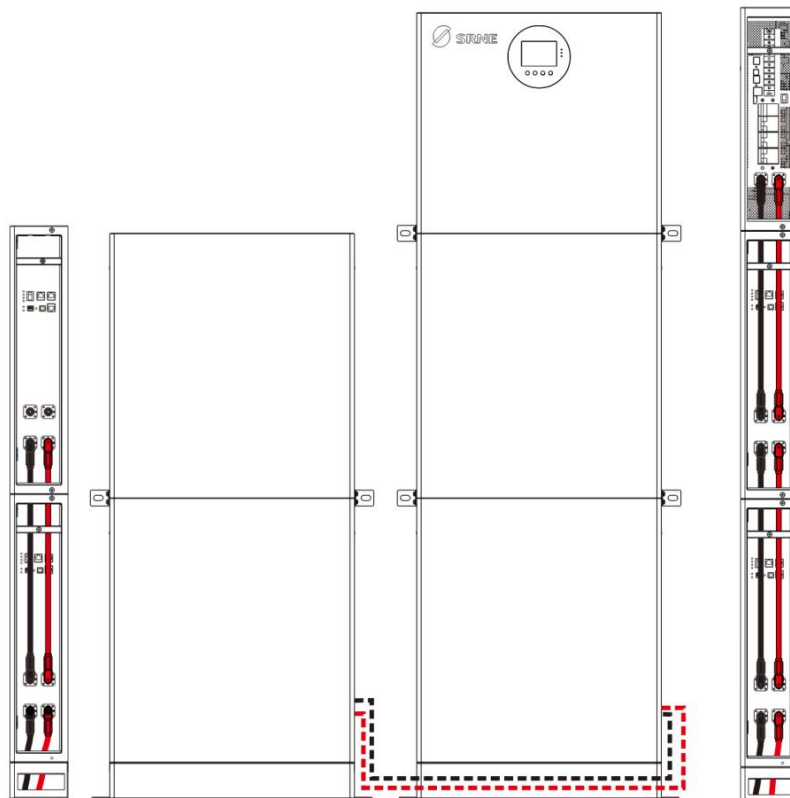
Battery wire connection

Signal line connection and address setting

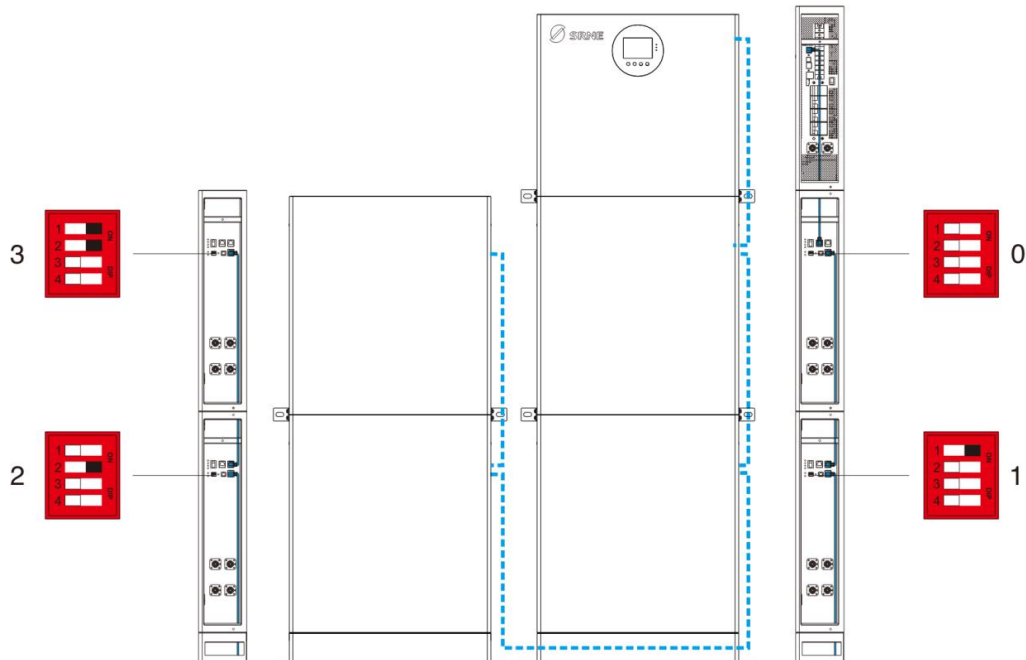

6.5 Electrical Connection of Two Systems In Parallel

6.5.1 Connecting Power Cord

You can choose to connect 2 sets of battery systems through a parallel power cable.

Parallel connection cable of battery modules are optional products. If necessary, please contact your local dealer.

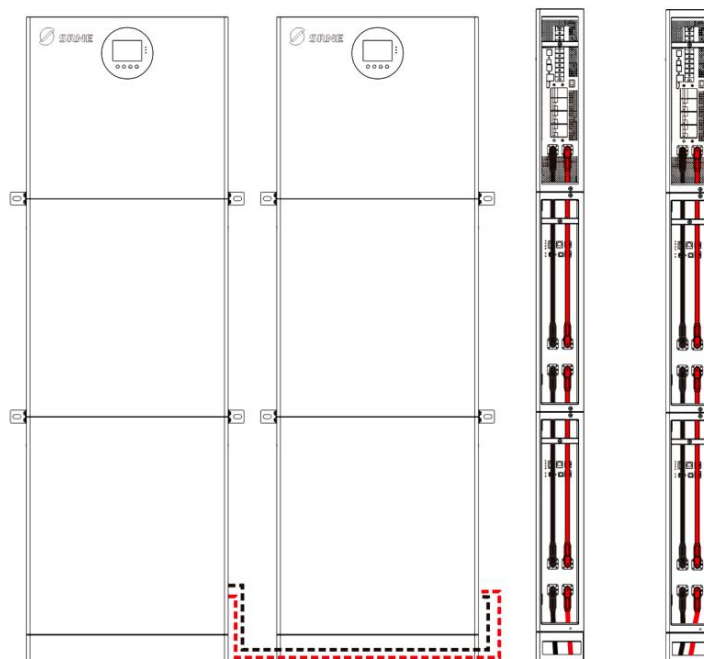

6.5.2 Connecting Signal Line

The battery at address 0 needs to be connected to the inverter, and the other inverter does not need to be connected to a communication cable.

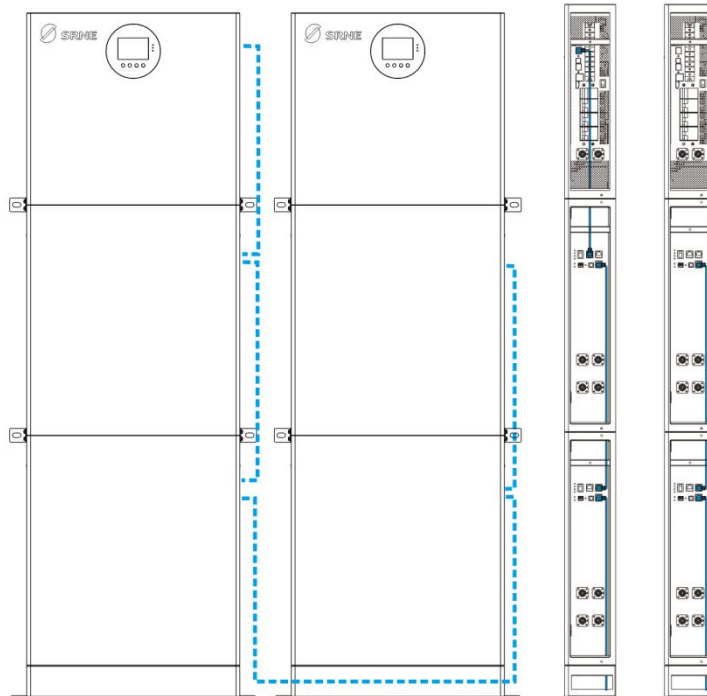

6.5.3 Battery Modules Address Setting

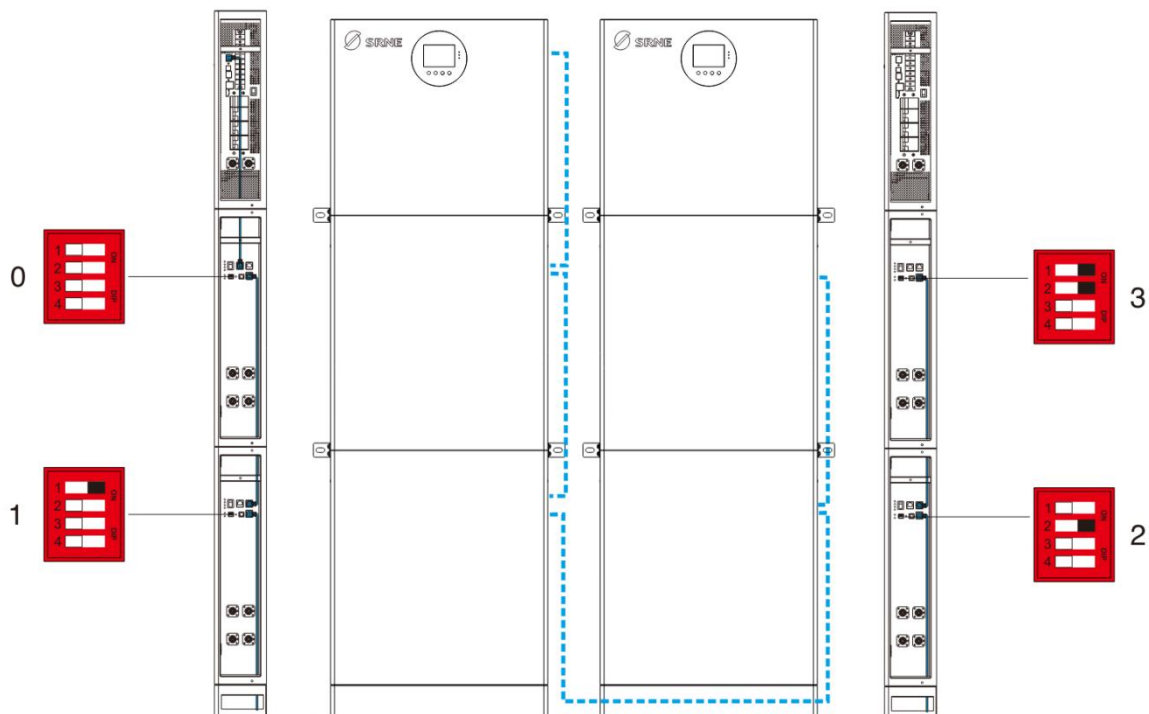

6.5.4 AC OUT Wiring & AC IN Wiring

When connected, L must be connected to L, N to N wire, PE to PE, and ensure on.

The connection should be correct and the length and diameter of the connection should be the same before the electric startup, so as to avoid the abnormal work of the output of the parallel system caused by the wrong AC IN wiring:

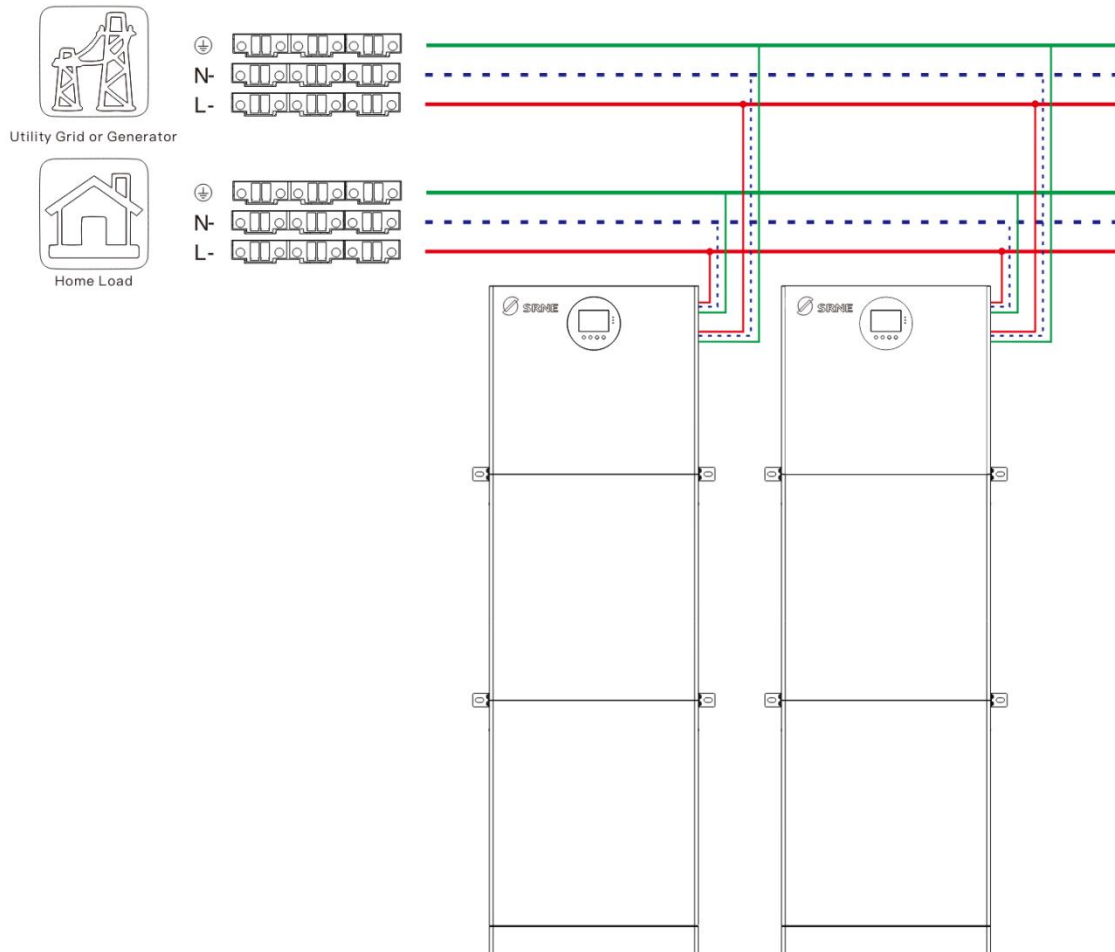

6.5.5 Parallel Communication Line Connection

Communication cable and current sharing cable are optional products. If necessary, please contact your local distributor.

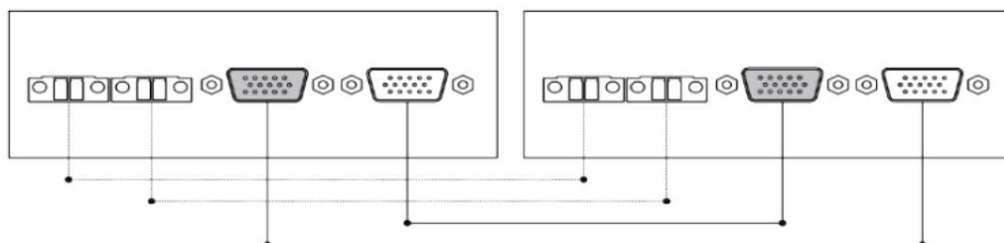

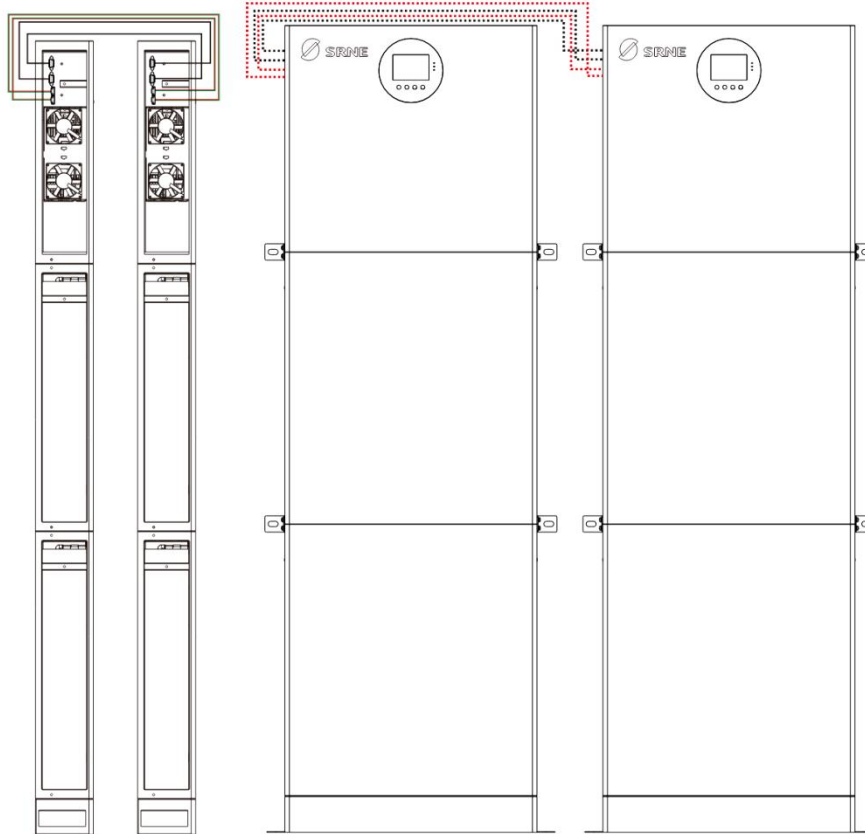

6.5.6 Set inverter parallel mode

The 31st setting needs to be set to PAL.

7 System Debugging

7.1 Inspections Before Power-On

No.	Inspection items	Acceptance criteria	Validation
1	The energy storage is installed in place	The installation is correct, secure and reliable.	<input type="checkbox"/> Yes <input type="checkbox"/> No
2	The installation environment meets requirements	The installation space is reasonable and the environment is clean and tidy without any construction	<input type="checkbox"/> Yes <input type="checkbox"/> No
3	The power cord is correctly connected	The positive and negative terminals are connected correctly without any missing.	<input type="checkbox"/> Yes <input type="checkbox"/> No
4	The signal line is correctly connected	The signal line is connected reliably, and there is no wrong position	<input type="checkbox"/> Yes <input type="checkbox"/> No
5	The grounding is reliable	The grounding wire is correctly and reliably connected.	<input type="checkbox"/> Yes <input type="checkbox"/> No
6	The switch of the energy storage battery module is off	All switches connected to the energy storage are in the "OFF" state.	<input type="checkbox"/> Yes <input type="checkbox"/> No
7	All breaker of the battery module are off	All breaker of the battery module are in the "OFF" state.	<input type="checkbox"/> Yes <input type="checkbox"/> No

7.2 Power-On of Power Module

7.2.1 Inverter Breaker Sequence

First, Turn on the battery input breaker switch.

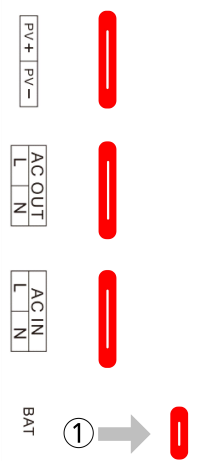

7.2.2 Power-On of Energy Storage Battery Module

After turn on the battery switch and confirmation, turn on the switch of the energy storage battery module. If there are multiple modules, please turn on the power switch one by one according to the address sequence.

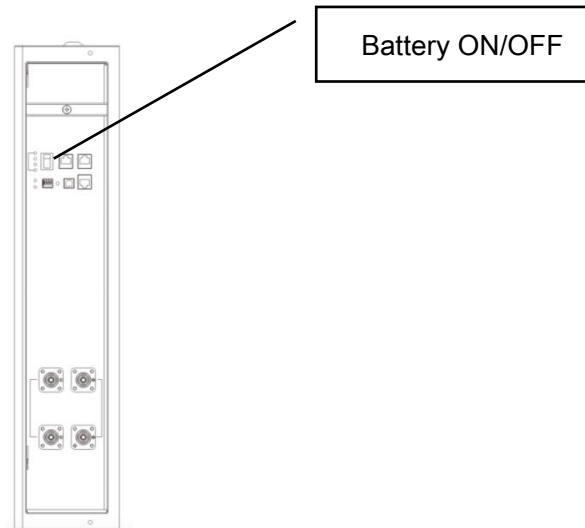

After the power switch is turned on, the LED indicator will light up or flash. The meaning of the LED indicator is as follows.

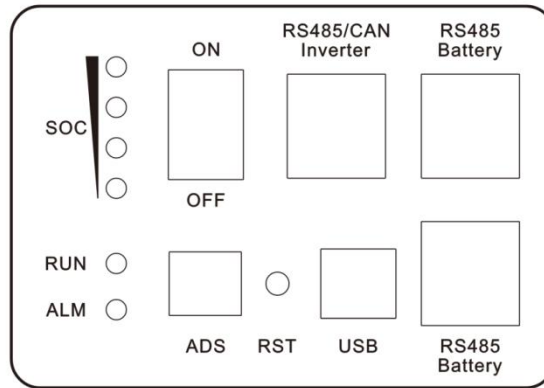







System Status	Events	RUN	ALM
POWER OFF	Power Off	OFF	OFF
Steady	Normal	Blinking1	OFF
	Alarm	Blinking1	Blinking3
Charging	Normal	ON	OFF
	Alarm	ON	Blinking3
	Over Charge Protection	ON	OFF
	High temperature, Over Current	OFF	ON
Discharging	Normal	Blinking3	OFF
	Alarm	Blinking3	Blinking3
	Over Discharge Protection	OFF	OFF
	Over Current , Short Current	OFF	ON

LED blinking description

Blinking	LED ON	LED OFF
Blinking1	0.25S	3.75S
Blinking2	0.5S	0.5S
Blinking3	0.5S	1.5S

7.2.3 Capacity Indicator

Capacity indicator LED	SOC
	0 ~ 25%
	25 ~ 50%
	50 ~ 75%
	75 ~ 100%
 : LED ON  : LED OFF	

7.2.4 Power-On of Inverter

After all the loads are connected, press the button switch on the side of the inverter. If the AC/INV indicator blinks, it indicates that the inverter works properly, then turn on the PV, AC output and AC input breaker switch.

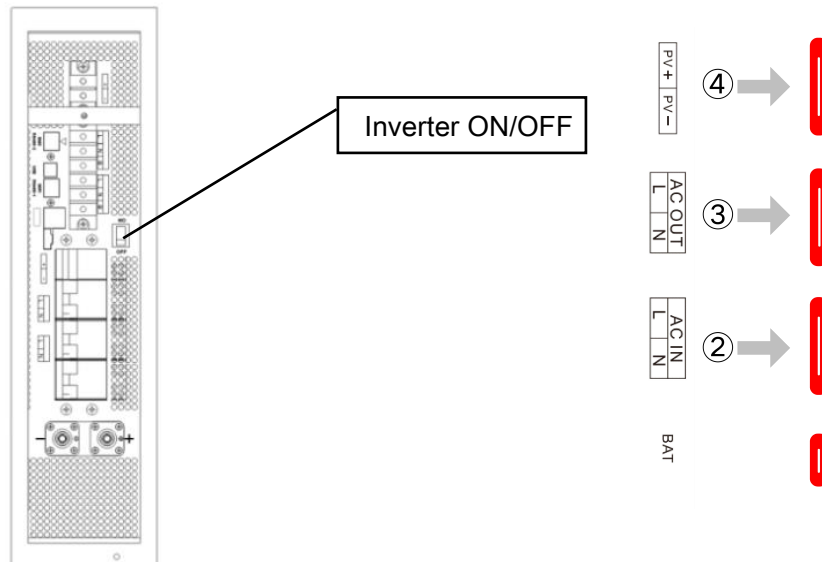

7.2.5 Inverter LED And Button Function Description

After the power module works normally, the indicator lights are described as follows:

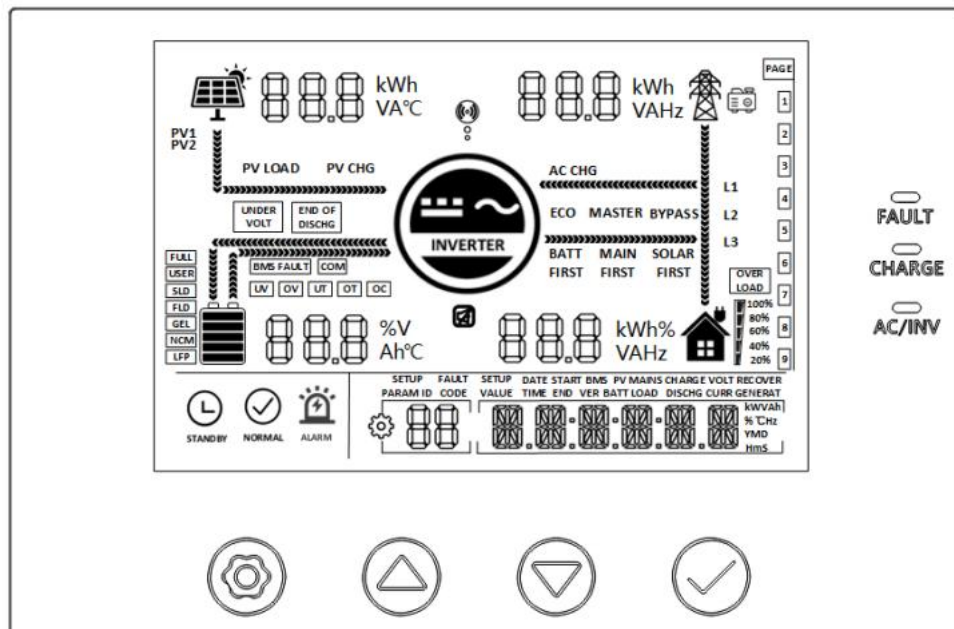

Indicators introduction

Indicator lights	Color	State	Description
AC/INV	Yellow	Always ON	Mains output
		Blinking	Inverter output
CHARGE	Green	Blinking	The battery is being charged
		Always ON	Charging is completed
FAULT	Red	Always ON	Fault state

Operation buttons introduction







Function buttons	Description
SET	Enter/Exit Settings menu
UP	Previous choice
DOWN	Next choice
ENT	Confirm/Enter Options under the settings menu

7.2.6 Inverter Real-time Data Viewing Method

On the LCD main screen, press the “UP” and “DOWN” buttons to scroll through the real-time data of the machine.

Page	PV side parameters	Battery side parameters	Mains side parameters	Load side parameters	Comprehensive parameters
1	PV Voltage	Battery Voltage	AC Voltage	Load Voltage	Current Time
2	PV Current	Battery Current	AC Current	Load Current	Current Date
3	PV Power	BMS Batt SOC	AC Power	Load Power	PV Total kWh
4	PV Today kWh	BMS Batt Voltage	Reserved	Load Today kWh	Load Total kWh
5	PV Temperature	INV Temperature	AC Frequency	Load Frequency	RS485 Address
6	Maintenance Parm	Battery Rated Voltage	Reserved	Load kVA	Soft Version
7	PV Rated Voltage	Battery Rated Current	Reserved	Load Rated Power	Parallel Mode

7.2.7 PCS Parameter Adjustment

Key Operation Instructions: Enter the setting menu and exit the setting menu, please press , After entering the setting menu, the parameter number [00] will flash. At this time, you can press the  and  key to select the parameter code to be set. Then press  to enter the parameter editing state, at this time, the value of the parameter flashes, adjust the value of the parameter through the  and , and finally press  to complete the editing of the parameter and return to the parameter selection state.

Parameter Number	Parameter Name	Setting options (Default)	Description
00	Exit	ESC	Menu of Exit Settings
01	Supply Priority Mode	AC1ST	Mains Power First Mode, switch to the Inverter only when the Mains Power has failed
		BT1ST	Inverter First Mode: switch to Mains Power only when the battery is under-voltage or lower than Parameter [04] Set Value.
		PV1ST	Solar First Mode: switch to Mains Power when PV has failed or battery is lower than Parameter [04] Set Value.
02	Output Frequency	50.0	Bypass self-adaptation; when the mains is connected, it automatically adapts to the mains frequency; when the mains is disconnected, the output frequency can be set through this menu. The default output frequency of the 230V machine is 50HZ, and the 120V machine is 60HZ.
		60.0	
03	AC Input Voltage	UPS	The input mains voltage range of 230V machine is 170~280V Mains input voltage range of 120V machine: 90~140V
		APL	The input mains voltage range of 230V machine is 90~280V Mains input voltage range of 120V

Parameter Number	Parameter Name	Setting options (Default)	Description
			machine: 90~140V
04	Battery to Mains	48.0V	When the Parameter [01] = BT1ST/PV1ST, the battery voltage is lower than the set value, and the output is switched from inverter to Mains Power, and the set range is 40V~52V.
05	Mains to Battery	55.2V	When the Parameter [01] = BT1ST/PV1ST, the battery voltage is higher than the set value, and the output is switched from mains to inverter, and the set range is 48V~60V.
06	Charging mode	Hybrid	Hybrid charging by PV and under utility grid give priority to PV, and use utility grid for supplementary if PV energy is insufficient. When the PV energy is sufficient, the utility grid will stop charging. Note: PV and utility grid are available for charging at the same time only when the bypass output is loaded, and only PV charging can be activated when the inverter is working.
		AC1ST	The Mains Power is charged first, and PV charging is started only when the Mains Power has failed
		PV1ST	Priority shall be given to charging by PV and mains charging will be initiated only when the PV has failed.
		ONLYPV	Only PV charging, no mains charging is enabled.

Parameter Number	Parameter Name	Setting options (Default)	Description
07	Maximum Charging Current	100A	Set Range of 0~100A
08	Battery type	LFP16	LFP14/LFP15/LFP16 are corresponding to Battery Series of 14, 15 and 16, and their default constant charge voltages are 49.6V, 53.2V and 56.8V respectively, which can be adjusted.
		NCM13/NCM14	NCM lithium battery, adjustable
09	Boost Voltage	56.8V	Setting of Boost Voltage: Set Range of 48V~58.4V, Step 0.4V, available when the battery type is user-defined and lithium battery.
10	Maximum Boost Duration	120	Setting of Maximum Boost Duration, which is the maximum charging time when the voltage reaches the Parameter [09] when charging at constant voltage, with the Set Range of 5min~900min, and Step of 5min. It is available when the battery type is user-defined and lithium battery.
11	Float charge voltage	56.8V	Floating Charge Voltage, with the Set Range of 48V~58.4 V, Step of 0.4 V, and available when battery type is user-defined.
12	Over-discharge voltage	46.4V	Over-discharge Voltage: the battery voltage is lower than such criterion, and the Inverter output is turned off after the time delay parameter is set to [13], with the Set Range of 40V~48V and Step of 0.4V. available when the battery

Parameter Number	Parameter Name	Setting options (Default)	Description
			type is user-defined and lithium battery.
13	Over discharge Delay Time	5S	Over-discharge Delay Time: when the battery voltage is lower than the Parameter [12], the inverter output is turned off upon delay of time set by this Parameter, with the Set Range of 5S~50S, Step of 5S, available when the battery type is custom and lithium battery.
14	Battery under voltage alarm point	49.6V	Battery under-voltage alarm point: when the battery voltage is lower than such criterion, under-voltage alarm will be given, the output will not be shut down, with the Set Range of 40V~52V, Step of 0.4V, available when battery type is user-defined and lithium battery.
15	Battery Discharge Limit Voltage	44.8V	Battery Discharge Limit Voltage: the battery voltage is lower than such criterion, output and shut down immediately. Set Range of 40V~52V, Step of 0.4V, available when the battery type is user-defined and lithium battery.
16	Equalization charge	DIS	No equalization charging
		ENA	Enable equalization charging, only Flooded lead-acid batteries, sealed lead-acid batteries and user-defined are effective
17	Equalization Voltage	58V	Equalization Charging Voltage, with the Set Range of 48V~58V, Step of 0.4V, available for Flooded lead-acid battery, sealed lead-acid

Parameter Number	Parameter Name	Setting options (Default)	Description
			battery and user-defined
18	Equalization Charging Time	120	Equalization Charging Time, with the Set Range of min~900min, Step of 5min, available for Flooded lead-acid battery, sealed lead-acid battery and user-defined
19	Equalized Charging Delay	120	Equalization Charging Delay, with the Set Range of min~900min, Step of 5min, available for Flooded lead-acid battery, sealed lead-acid battery and user-defined
20	Equalization Charge Interval Time	30	Equalization Charge Interval Time, 0~30d, Step of 1d, available for Flooded lead-acid battery, sealed lead-acid battery and user-defined
21	Equalization Charging Start-Stop	ENA	Start equalization charging immediately
		DIS	Stop equalization charging immediately
22	ECO mode	DIS	NO ECO mode
		ENA	When the ECO mode is enabled, if the load is below 50W, the inverter output is delayed for 5 minutes and then the output is turned off. When the hull switch is pressed to the "OFF" State, and then pressed to the "ON" State, the inverter will resume the output
23	Overload Automatic Restart	DIS	Overload automatic restart is disabled. If overload occurs, the output will be shut down, and the machine will not be restarted.
		ENA	Enable overload auto restart. If overload occurs, shut down output, delay the machine for 3

Parameter Number	Parameter Name	Setting options (Default)	Description
			min and then restart the output. After 5 times in total, no startup will be resumed.
24	Auto restart upon over-temperature	DIS	Over-temperature automatic restart is disabled. If over-temperature occurs, the output will be shut down, and the machine will not be restarted for output.
		ENA	Enable automatic restart upon over-temperature. If over-temperature occurs, shut down output, and restart output after the temperature has dropped.
25	Buzzer Alarm	DIS	No Alarm
		ENA	Enable alarm
26	Mode Change Reminder	DIS	Alarm is disabled when the status of the main input source has change.
		ENA	Alarm is disabled when the status of the main input source has change.
27	Inverter Overload to Bypass	DIS	Automatic switch to Mains Power is disabled when the Inverter is overloaded.
		ENA	Automatic switch to Mains Power when the inverter is overloaded.
28	Current of charging under grid electricity	60A	AC output 230Vac, with the Set Range of 0~60A
		40A	AC output 120Vac, with the Set Range of 0~40A
30	RS485 Address Setting	1	RS485 communication address can be set within the range of 1~254

Parameter Number	Parameter Name	Setting options (Default)	Description
31	AC output mode (can be set in the standby mode only)	SIG	Single machine setting (for S & U model)
		PAL	Single-phase parallel connection setting (for S & U model)
		[31] 2P0/2P1/2P2	Split-phase parallel connection setting (for U model)
		<p>When the parameter [38] setting item=120 for U series model.</p> <p>All connected P1-phase inverters are set to "2P0" :</p> <p>1) If all connected P2-phase inverters are set to "2P1", AC output line voltage difference is 120 degrees (L1-L2), line voltage is $120 \times 1.732 = 208\text{Vac}$; Phase voltage is 120Vac (L1-N; L2-N).</p> <p>2) If all connected P2-phase inverters are set to "2P2", AC output line voltage difference is 180 degrees (L1-L2), line voltage is $120 \times 2 = 240\text{Vac}$; Phase voltage is 120Vac (L1-N; L2-N).</p>	
		[31] 3P1/3P2/3P3	Three-phase parallel connection setting (for S & U model)
		<p>All machines in phase 1 must be set as [3P1] All machines in phase 2 must be set as [3P2] All machines in phase 3 must be set as [3P3]</p> <p>1.When the output voltage set in the setting [38] is 120 Vac (U model)</p> <p>At present the line voltage between L1 in phase 1 and L2 in phase 2 is $120 \times 1.732 = 208\text{ Vac}$, similarly the line voltage between L1-L3, L2-L3 is 208 Vac; the single phase voltage between L1-N, L2-N, L3-N is 120 Vac.</p> <p>2.When the output voltage set in the setting [38] is 230Vac (S model)</p> <p>At present the line voltage between the live wire L1 in phase 1 and the live wire L2 in phase 2 is $230 \times 1.732 = 398\text{Vac}$, and similarly the line voltage between L1-L3, L2-L3 is 398Vac; the single phase voltage</p>	

Parameter Number	Parameter Name	Setting options (Default)	Description
			between L1-N, L2-N, L3-N is 230Vac.
32	Communication function	SLA	RS485-2 port for PC or telecommunication control.
		485	RS485-2 port for 485-BMS communication.
33	BMS communication protocol		When [32] enables BMS communication, the corresponding lithium battery manufacturer brand should be selected for communication
			PAC=PACE , RDA=Ritar , AOG=ALLGRAND , OLT=OLITER , HWD=SUNWODA, DAQ=Dyness, WOW=SRNE, PYL=PYLONTECH , UOL=WEILAN
34	PV grid-connected power generation function	DIS	Disable this Function
		TOGRID	In the utility bypass state, when no battery is connected or when the battery is full, the surplus PV energy is fed back to the grid.
		TOLOAD	In the utility bypass state, when no battery is connected or when the battery is full, the load power is supplied by the hybrid of PV and the utility.
35	Battery Under-voltage Recovery Point	52V	When the battery is under-voltage, the battery voltage should be greater than this set value to restore the inverter AC output of the battery, and the set range is 44V~54.4V.
36	Max PV charger current	100A	Max PV charger current. Setting range: 0~100A
37	Battery Recharge Recovery Point	52.8V	After the battery is fully charged, the inverter will stop charging, and when the battery voltage is lower than this Value, the Inverter will resume charging again. And the set range is 44V~54V.

Parameter Number	Parameter Name	Setting options (Default)	Description
38	AC Output Rated Voltage	230Vac	You can set: 200/208/220/240Vac
		120Vac	You can set: 100/105/110/120Vac
39	Charge current limiting method (when BMS is enabled)	LC SET	Max. battery charging current not greater than the value of setting 【07】
		LC BMS	Max. battery charging current not greater than the limit value of BMS
		LC INV	Max. battery charging current not greater than the logic judgements value of the inverter.
40	1-section start charging time	00:00:00	Set Range: 00: 00-23: 59: 00
41	1-section end charging time	00:00:00	Set Range: 00: 00-23: 59: 00
42	2-section start charging time	00:00:00	Set Range: 00: 00-23: 59: 00
43	2-section end charging time	00:00:00	Set Range: 00: 00-23: 59: 00
44	3-section start charging time	00:00:00	Set Range: 00: 00-23: 59: 00
45	3-section end charging time	00:00:00	Set Range: 00: 00-23: 59: 00
46	Sectional charging function	DIS	Disable this Function
		[46] ENA	After the sectioned charging function is enabled, the power supply mode will change to BT1ST, and system will enable the mains power charging only in the set charging period or battery over discharge; If the sectioned discharge function is enabled at the same time, the power supply mode of the system will change to AC1ST, which only enable the

Parameter Number	Parameter Name	Setting options (Default)	Description
			mains charging in the set charging period, and switch to the battery inverter power supply mode in the set discharge period or when the mains power is off
47	1-section start discharging time	00:00:00	Set Range: 00: 00-23: 59: 00
48	1-section end discharging time	00:00:00	Set Range: 00: 00-23: 59: 00
49	2-section start discharging time	00:00:00	Set Range: 00: 00-23: 59: 00
50	2-section end discharging time	00:00:00	Set Range: 00: 00-23: 59: 00
51	3-section start discharging time	00:00:00	Set Range: 00: 00-23: 59: 00
52	3-section end discharging time	00:00:00	Set Range: 00: 00-23: 59: 00
53	Sectional discharge function	DIS	Disable this Function
		ENA	After the sectioned discharge function is enabled, the power supply mode will change to AC1ST and the system will switch to battery inverter power supply only during the set discharge period or when the mains power is off
54	Current date setting	00:00:00	Set Range: 00:01: 01-99:12:31
55	Current time setting	00:00:00	Set Range: 00:00: 00-23:59: 59
56	Leakage protection function	DIS	Disable this Function
		ENA	Enable leakage protection function
57	Stop charging current	2A	Charging stops when the default charging current is less than this setting
58	Discharge alarm	15%	SOC alarm when capacity is less

Parameter Number	Parameter Name	Setting options (Default)	Description
	SOC setting		than this set value (valid when BMS communication is normal)
59	Cut-off discharge SOC Settings	5%	Stops discharging when the capacity is less than this setting (valid when BMS communication is normal)
60	Cut-off charge SOC Settings	100%	Stops charging when capacity is greater than or equal to this setting (valid when BMS communication is normal)
61	Switch to mains SOC Settings	10%	Switch to mains when capacity is less than this setting (valid when BMS communication is normal)
62	Switch to inverter output SOC Settings	95%	Switches to inverter output mode when capacity is greater than or equal to this setting (valid when BMS communication is normal)

7.3 Time-slot Charging/Discharging Function

The series is equipped with a time-slot charging and discharging function, which allows users to set different charging and discharging periods according to the local peak and valley tariffs, so that the utility power and PV energy can be used rationally.

When mains electricity is expensive, the battery inverter is used to carry the load; when the mains electricity is cheap, the mains electricity is used to carry the load and charge, which can help customers to save electricity costs to the greatest extent.

The user can turn on/off the time-slot charging/discharging function in setup menu parameter 46 and 53 and set charging and discharging slot in parameter 40-45, 47-52. Below are examples for users to understand the function.



Before using this function for the first time, please set the local time in parameter items 54, 55, then the user can set the corresponding time slot according to the local peak and valley tariff charges.

Peak-Valley Electricity Tariff

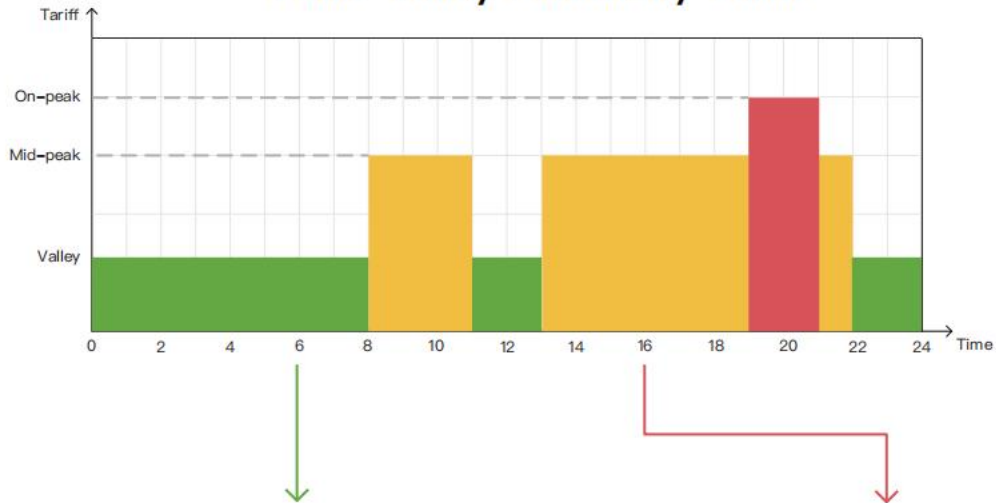

Time-slot Utility Charging/Carrying Function



With 3 definable periods, the user can freely set the mains charging/carrying time within the range of 00:00 to 23:59. During the time period set by the user, if PV energy is available, PV energy will be used first, and if PV energy is not available or insufficient, utility energy will be used as a supplement.

Time-slot Battery Discharging Function



With 3 definable time periods, users can freely set the battery discharge time within the range of 00:00 to 23:59. During the time period set by the user, the inverter will give priority to the battery inverter to carry the load, and if the battery power is insufficient, the inverter will automatically switch to mains power to ensure stable operation of the load.

7.4 Dry Contact Function

Working principle: This dry contact can control the ON/OFF of the diesel generator to charge the battery.

Normally, the terminals are that the NC-N point is closed and the NO-N point is open;

When the battery voltage (SOC) reaches the low voltage disconnection point, the relay coil is energized, and the terminals turn to that the NO-N point is closed while NC-N point is open. At this point, NO-N point can drive resistive loads: 125VAC/1A, 230VAC/1A, 30VDC/1A.

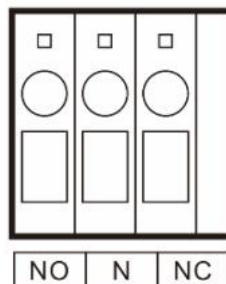

7.5 Install The Cover Plate

When all wiring is complete and the system is operating normally, close the side cover.

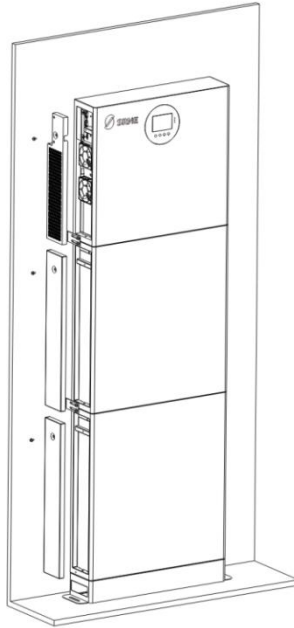

8 System Maintenance

8.1 System Power-Off



After the system is powered off, the case still has residual power and heat, which may cause electric shocks or burns. Therefore, protective gloves should be worn before operating the energy storage 5 minutes after the system is powered off. Maintenance operations on energy storage should be performed only after ensuring that all indicator lights of the energy storage are off.

Power-off operation steps of the system:

Step 1 Turn off the breaker switch between the inverter and AC output (If installed).

Step 2 Turn off the breaker switch between the inverter unit and AC input(If installed).

Step 3 Turn off the breaker switch between the inverter unit and the PV string(If installed).

Step 4 Turn off the battery breaker switch, all LED indicators are off.

Step 5 Turn off button on all storage battery modules, the energy storage is powered off successfully.

8.2 Routine Maintenance

To ensure the long-term and good operation of the energy storage system, it is recommended to perform the routine maintenance as described in this section.

Items	Methods	Maintenance interval
System cleanliness	Check if the radiator is covered or dirt on a regular basis.	Once every six months to one year.

Running status of system	<ul style="list-style-type: none"> Observe whether the energy storage appearance is damaged or deformed. Listen to whether the energy storage has any abnormal sound during running. When the energy storage is running, check whether the indicator of the energy storage battery is correct. 	Once every six months.
Electrical connection	<ul style="list-style-type: none"> Check if any cable connection is off or loose. Check if any cable is damaged, and especially if there are cuts on the sheath where the cable contacts with the metal surface. Check if the unused DC input terminals, energy storage terminals, COM ports, and covers are locked. 	Half a year after first debugging and testing, and once every six months to one year thereafter.
Grounding reliability	Check if the grounding cable is grounded reliably.	Half a year after first debugging and testing, and once every six months to one year thereafter.

8.3 Troubleshooting

8.3.1 Fault Code and Handling Methods

Fault code	Fault name	Whether it affects the output or not	Description
【01】	BatVoltLow	No	Battery undervoltage alarm
【02】	BatOverCurrSw	Yes	Battery discharge average current overcurrent software protection
【03】	BatOpen	Yes	Battery not-connected alarm
【04】	BatLowEod	Yes	Battery undervoltage stop discharge alarm
【05】	BatOverCurrHw	Yes	Battery overcurrent hardware protection
【06】	BatOverVolt	Yes	Charging overvoltage protection
【07】	BusOverVoltHw	Yes	Bus overvoltage hardware protection
【08】	BusOverVoltSw	Yes	Bus overvoltage software protection
【09】	PvVoltHigh	No	PV overvoltage protection
【10】	PvBuckOCSw	No	Buck overcurrent software protection
【11】	PvBuckOCHw	No	Buck overcurrent hardware protection
【12】	bLineLoss	No	Mains power down
【13】	OverloadBypass	Yes	Bypass overload protection
【14】	OverloadInverter	Yes	Inverter overload protection
【15】	AcOverCurrHw	Yes	Inverter overcurrent hardware protection
【17】	InvShort	Yes	Inverter short circuit protection

【19】	OverTemperMppt	No	Buck heat sink over temperature protection
【20】	OverTemperInv	Yes	Inverter heat sink over temperature protection
【21】	FanFail	Yes	Fan failure
【22】	EEPROM	Yes	Memory failure
【23】	ModelNumErr	Yes	Model setting error
【26】	RlyShort	Yes	Inverted AC Output Backfills to Bypass AC Input
【29】	BusVoltLow	Yes	Internal battery boost circuit failure
【30】	BatSocLow1	No	Battery Soc < 10%
【31】	BatSocLow2	No	Battery Soc < 5%
【32】	BatSocLowStop	Yes	Battery Soc < 1%, Turn off the inverter
【44】	Serial number error	Yes	If the serial number is not set by omission in production, please contact the manufacturer to set it
【58】	BMS communication error	No	Check whether the communication line is connected correctly and whether [33] is set to the corresponding lithium battery communication protocol
【59】	BMS alarm	No	Check the BMS fault type and troubleshoot battery problems
【60】	BmsBatTempLow	No	Battery low temperature warning
【61】	BmsBatTempHigh	No	Battery high temperature warning
【62】	BmsBatOverCurr	No	Battery over current warning
【63】	BmsBatVoltLow	No	Battery low voltage warning
【64】	BmsBatFullCharge	No	The battery is fully charged, and if the fault indicator lights up at the same time, the battery overvoltage warning.

8.3.2 Common Faults and Handling Methods

Faults	Handling measures
No display on the screen	Check if the battery air switch or the PV air switch has been closed; if the switch is in the "ON" state; press any button on the screen to exit the screen sleep mode.
Battery overvoltage protection	Measure if the battery voltage exceeds rated, and turn off the PV array air switch and Mains air switch.
Battery undervoltage protection	Charge the battery until it returns to the low voltage disconnection recovery voltage.
Fan failure	Check if the fan is not turning or blocked by foreign object.

Heat sink over temperature protection	When the temperature of the device is lower than the recovery temperature, normal charge and discharge control is resumed.
Bypass overload protection, inverter overload protection	① Reduce the use of power equipment; ② Restart the unit to resume load output.
Inverter short circuit protection	① Check the load connection carefully and clear the short-circuit fault points; ② Re-power up to resume load output.
PV overvoltage	Use a multimeter to check if the PV input voltage exceeds the maximum allowable input voltage rated.
Battery missed alarm	Check if the battery is not connected or if the battery circuit breaker is not closed.

8.4 Battery Storage and Maintenance

8.4.1 Battery Storage Requirements



Do not put the battery into fire. The battery may explode.

Do not open or damage the battery. The electrolyte flowing out from the battery is harmful to the skin and eyes. The electrolyte may also be toxic;

1. When being stored, the batteries shall be placed correctly in accordance with the marks on the packing case. Do not put them upside down or on the side.
2. When stacking up the battery packing cases, the stacking requirements on the outer package shall be met.
3. The batteries should be handled with care, and damage to batteries should be strictly prohibited.
4. Requirements for the storage environment:
 - Ambient temperature: -10°C to 55 °C, recommended storage temperature: 20°C to 30°C.
 - Relative humidity: 5%RH-80%RH.
 - Dry, well ventilated, and clean.
 - The corrosive organic solvents, gases and other substances shall be kept away.
 - Exposing to direct sunlight shall be avoided.
 - The distance from the heat source should not be less than two meters.
5. When being stored, the battery shall be disconnected from the external connection. If there is an indicator light on the battery panel, the indicator light shall be off.
6. When the stored batteries are going to be delivered, the first-in first-out principle should be followed.
7. After the battery is produced and tested, it shall be recharged to at least 50% SOC before being stored. If the device will not be used for a long period of time, discharge the battery to 45% to 60% of the battery capacity and disconnect the battery output to avoid the battery runs out;
8. Do not touch the battery pack with wet hands.
9. Do not squeeze, drop, or pierce the battery.

10. The battery should always be disposed in accordance with local safety regulations.
11. The battery should be stored and recharged in accordance with this User's Manual.
12. Do not reverse polarity of the battery when storing or transporting the batteries, the batteries shall not be stacked up without protective packaging, and the number of stacked packed batteries should not exceed the number specified on the packaging.
13. All operators of the energy storage system shall comply with the user manual, installation and service manual, and quality assurance requirements. Any damage to the device resulting from neglecting or misreading of the user's manual, installation and service manual, and the quality assurance requirements will invalidate the product warranty.

8.4.2 Requirements for Charging of Battery

The batteries to be stored for a long period of time (unused, for more than 3 months) must be kept in a dry and cool place. The storage voltage is 51V-53V. The batteries should be stored in a clean environment of $23 \pm 2^{\circ}\text{C}$ and humidity of 45%-75%. If the battery will be shelved and not used for a long period of time, it should be recharged every 3 months to ensure that the battery voltage is within the above range.

As for batteries and long-term storage, routine maintenance is required. Please charge the battery to 40% SOC at a current of 0.2C according to the requirements in the table below.

Ambient temperature for storage	Relative humidity for storage environment	Storage Time	SOC
<-10°C	/	Prohibited	/
-10~25°C	5%~70%	≤12 months	30%≤SOC≤60%
25~35°C		≤6 months	
35~45°C		≤3 months	
>45°C	/	Prohibited	/

8.5 Device Cleaning

It is recommended to clean and maintain the product from time to time. When cleaning, the dust and stains on the product shall be removed with a piece of soft dry cloth or vacuum cleaner, especially when cleaning the heat dissipation and air vents on both sides of the product. The product shall not be cleaned with organic solvents, corrosive liquids and other cleaning products.

If the fan fails, it can be replaced by a professional.

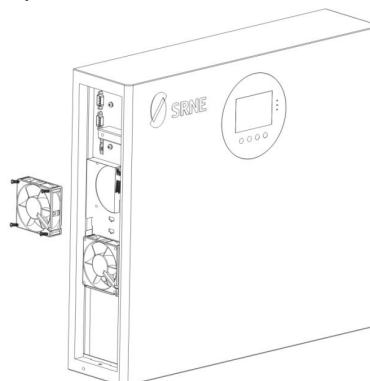

9 Technical Data

9.1 Power Module Data

		SR-EOV05C-220	SR-EOV05C-110
Battery Inverter	Rated Output Power	5000W	5000W
	Maximum Peak Power	10000VA	10000VA
	Power Factor	1	1
	Rated Output Voltage (Vac)	220Vac	110Vac
	Frequency	50Hz	60Hz
	Auto Switch Period	< 10ms	< 10ms
	THD	< 3%	< 3%
AC Charge	Maximum AC Charge Power	3150W	2100W
	AC Charging Current Range	60A	40A
	Rated Input Voltage	220/230Vac	110/120Vac
	Input Voltage Range	90 ~ 280Vac	90 ~ 140Vac
AC Output	Rated Output Power	5000W	5000W
	Maximum Output Current	30A	45A
	Frequency	50Hz	60Hz
	Overload Current	40A	63A
PV Charge	Solar Charge Type	MPPT	MPPT
	Maximum Output Power	5500W	5500W
	PV Charging Current Range	100A	100A
	PV Operating Voltage Range	120 ~ 500V	120 ~ 500V
	MPPT Voltage Range	120 ~ 450V	120 ~ 450V
General Data	Operating Temperature Range	-15°C ~ 55°C	-15°C ~ 55°C
	Storage Temperature Range	-25°C ~ 60°C	-25°C ~ 60°C
	Humidity Range	5% to 95%	5% to 95%
	Nominal Operation Altitude	< 2000m	< 2000m
	Cooling Mode	Force-Air Cooling	Force-Air Cooling
	Noise	60dB(A)	60dB(A)
	Ingress Protection Rating	IP20	IP20
	Certification	CE(EN62109-1)	CE(EN62109-1)
	EMC Certification Level	EN61000, C2	EN61000, C2
	Gross Weight	30Kg	30Kg
	Dimension L× D× H	500×555×130	500×555×130

9.2 Battery Module Data

Battery Type	LiFePO4
Battery Energy	5.12kWh
Battery Capacity	100AH
Battery Rated Voltage	51.2V
Battery Working Voltage Range	44.8 ~ 57.6V
Standard charge current	50A
Standard discharge current	50A
Maximum Charging Current	100A
Maximum Discharging Current	100A
DOD	80%
Parallel Quantity	4
Designed Life-span	6000 (80%DOD,0.5C,25°C)
Operating Temperature	Charge : 0 ~ 45°C Discharge : -10 ~ 45°C
Operation Humidity	5% ~ 85%
Nominal Operation Altitude	< 3000m
Ingress Protection Rating	IP20
Recommended Operation Environment	Indoor
Installation Method	Vertical
Gross Weight	50kg
Dimension L× D× H	600×555×130

10 Product Dimensions and Packaging

10.1 Product Dimensions

The external dimensions of the inverter module is 500*555*130mm, the external dimensions of the energy storage battery module is 600*555*130mm, the external dimensions of the base module is 80*635*130mm.

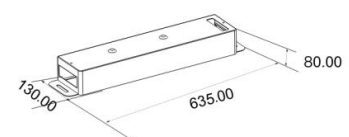
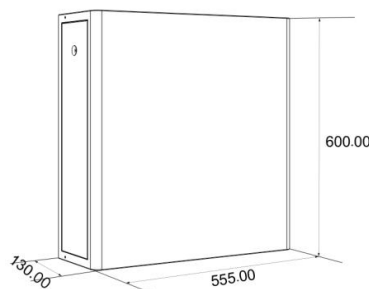
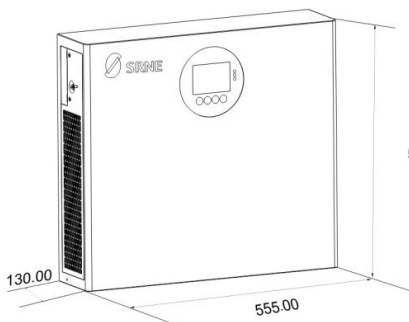

10.2 Package Dimensions

The package size of a single energy storage battery module is 644*698*199mm.

The package size of an inverter module is 644*689*199mm.

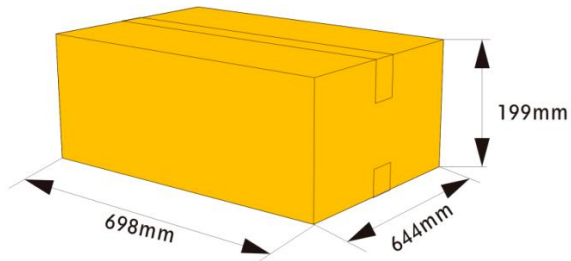

Inverter module

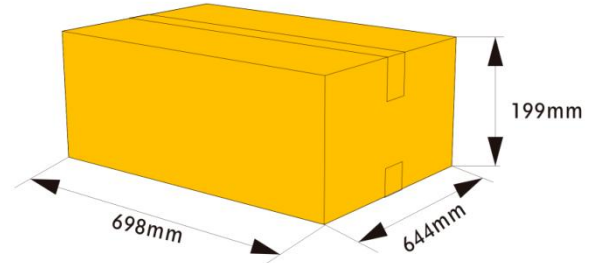

Energy storage battery



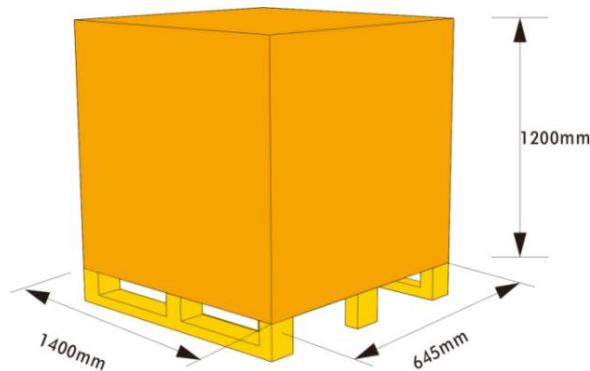

The energy storage battery module and Inverter module are packed in wooden cases with the size of 1120*1400*645mm , the number of packs is 10PCS, and the total weight is 400Kg.

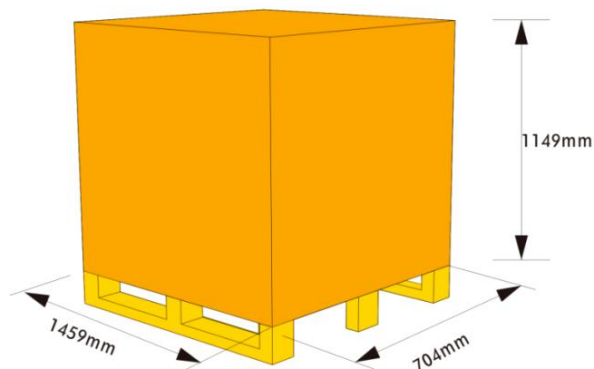



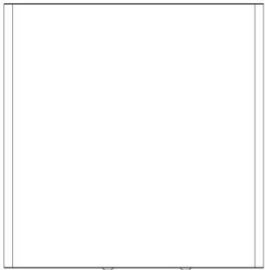

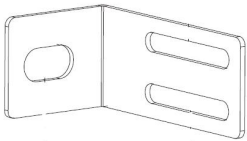
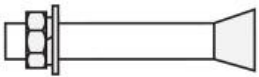
The energy storage battery module is packed in wooden cases with the size of 1149*1459*704mm, the number of packs is 10PCS, and the total weight is 600kg.

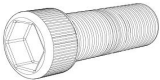
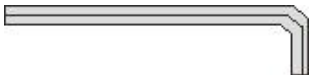

10.3 Packaging List

NO.	Picture	Item	Quantity	Specification	Source
1		Inverter	1	5.0kW/48V,110V/220V	Inverter Package
2		Battery	1	5.12kWh/51.2V	Battery Package
3		Base	1	635*130*80mm	Inverter Package
4		Mounting Frame	2	80*44mm	Battery Package
5		Mounting Frame Screw	4	M8*60 expansion bolt	Battery Package
6		Screw	6	M5*10	Battery Package
7		Fixing screw	2	M6*35	Battery Package
8		Hexagon wrench	1	120*30mm	Battery Package

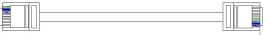
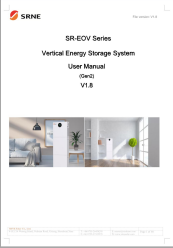
9		Power cable	1	560mm,4AWG	Battery Package
10		Signal cable	1	700mm	Battery Package
11		Parallel communication line	1	1.2m	Inverter Package (Optional)
12		Current sharing detection line	1	1.2m	Inverter Package (Optional)
13		Expand Capacity Power Cable	1	1.5m,4AWG	(Optional)
14		Expand Capacity Signal cable	1	2.0m	(Optional)
15		User Manual	1		Inverter Package